



Product name	XW8400 Host/ AE computer
Identification code(s)	4522 132 6462x
Total weight [kg]	28 kg
Manufacturer	Hewlett Packard
Address	Orteliuslaan 1000
Zip code	3528 BD Utrecht
Country	The Netherlands
Electronic info	

Recycling information

Special Attention	Items	Location
	None	

Batteries	Items, type	Location
	Lithium battery type CR2032 (3V)	Figure 1a

Hazardous substances	Items	Location
	Printed Circuit Boards (PCB) one in the power supply with a surface greater than 10 square cm.	Figure 2
	Printed Circuit Boards (PCB) system board (motherboard) with a surface greater than 10 square cm.	Figure 1b
	Printed Circuit Assemblies (PCA) maximal seven add-in cards (PCI) with a surface greater than 10 square cm.	Figure 3
	Printed Circuit Assemblies (PCA) maximal eight add-in cards (DIMMs) with a surface greater than 10 square cm.	Figure 1a
	Fifteen attached to the power supply boards. Electrolytic Capacitors / Condensers measuring greater than 2.5 cm in diameter or height.	Figure 2

 Fluids and gases	Items	Location
	None	

Name: WEEE passport Host/AE computer XW8400	12NC: 4522 132 64620	Version: 00 Doc.Date: 2007-04-05
Author:	Pag.: 1 of 3	Group No: 579E Section: - Status: Draft

Locations as mentioned in the Passport (Information in pictures)

Place sketch(es) or photo(s) here, and indicate issues using icons:

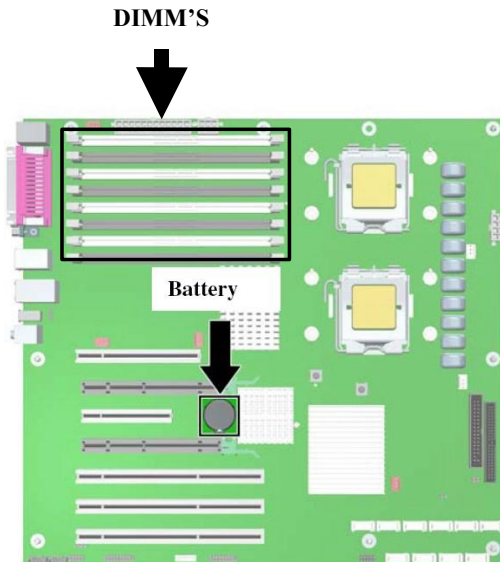

Figure 1a

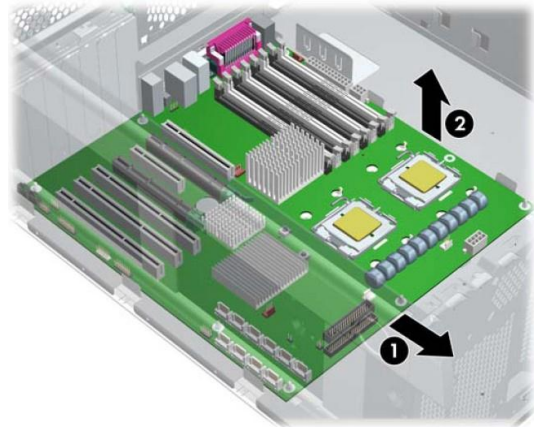

Figure 1b

Remove the system battery. Press on the release tab of the battery holder. Rotate the battery beyond the latch and lift it straight up.

Remove the system board. Slide the board forward 1 to disengage the mounting standoffs from the chassis. Lift the board out of the chassis 2.

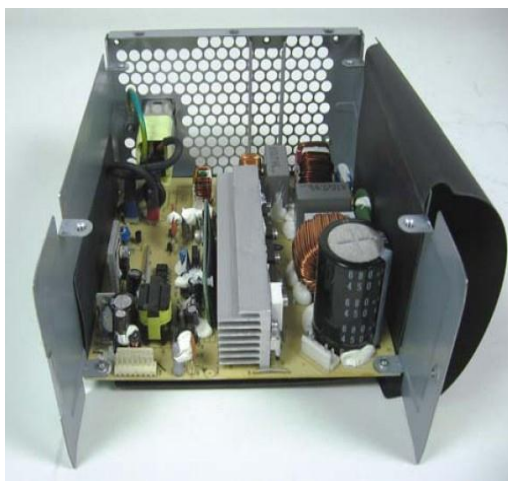

Figure 2a



Figure 2b

Name:	WEEE passport Host/AE computer XW8400	12NC:	4522 132 64620	Version: 00
Author:		Group No: 579E	Section: -	Doc.Date: 2007-04-05
	Pag.: 2 of 3			Status: Draft



Ensure that all capacitors are safely discharged. Use a diagonal cutter to remove the desired components from both PCB cards. (Note that some components may need to be unsoldered if a diagonal cutter does not fit between the component and the PCB card.)

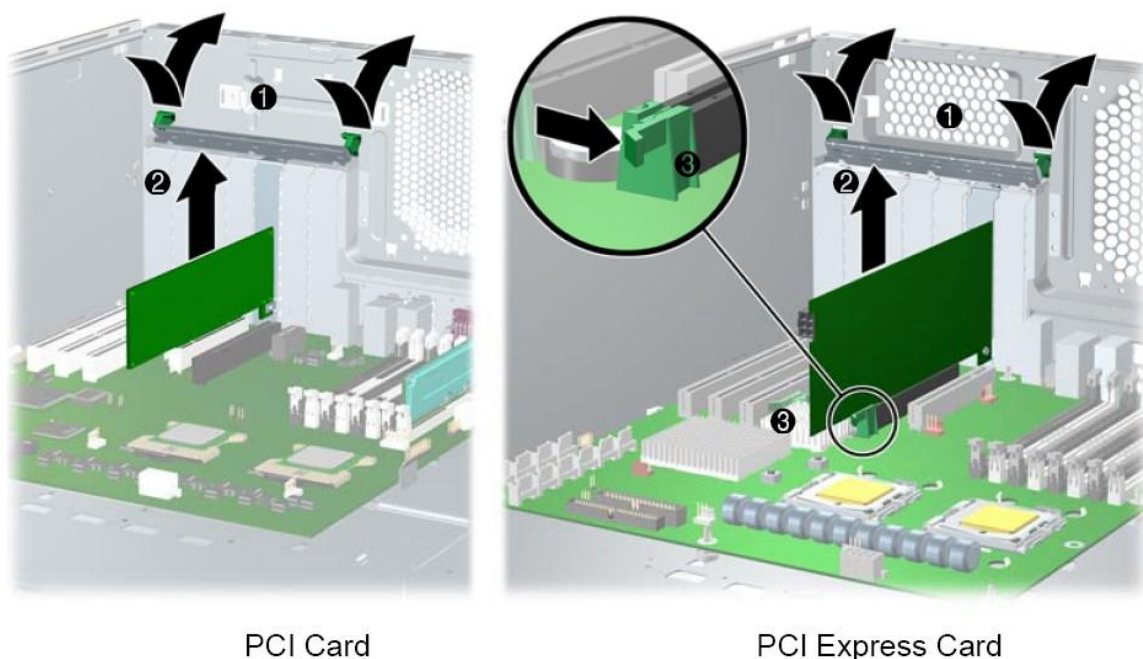

Figure 3

Remove the PCI retainer by pressing down on it, then out 1. Lift the PCI card out of the chassis 2. For PCI Express cards, first remove the power supply cable (not shown) if required. Then move the release lever 3 and lift the card out of the chassis.

Name:	WEEE passport Host/AE computer XW8400	12NC:	4522 132 64620	Version: 00
Author:		Pag.: 3 of 3	Group No: 579E	Doc.Date: 2007-04-05
			Section: -	Status: Draft