





Product name:	PrimaryDiagnost AR	
Identification code(s)	704310	
Total weight (in Kg)	1056 kg	
Producer/ Manufacturer	Name company:	Philips India Limited
	Address:	PLOT NO B-79, MIDC, PHASE II, CHAKAN TALUKA – KHED, VILLAGE – SAWARDARI, DISTRICT: PUNE, MAHARASHTRA
	Zip code:	410501
	Country:	India

Recycle Info	Items:	Location
Special attention 	For dismantling activities Treatment Facilities must consider the national requirements.	--
	Be aware of possible contaminated system parts and materials.	--
	For personnel that can come in contact with contaminated material, preventive measurements pursuant to national requirements must taken into account.	--
	Removal of units/weights can cause the system to tilt	--
	Removal of units/weights can cause unexpected movements	--
	High voltage parts are marked with 	Fig 2[1]
 Fluids / Gases	Items: Di-Electric Oil inside X-ray Tube	Location Fig 1[5]
Batteries 	Type: Li-ion in generator	Location Fig 2[2]
	Substances:	Location

	Lead(Pb) - PCBs in X-Ray Generators	Fig 2[3]
	Lead(Pb) - Xray Tube and Collimator	Fig 1[1,2]
	Anti-Scatter Grid	Fig 1[3]

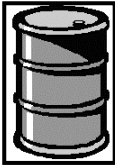
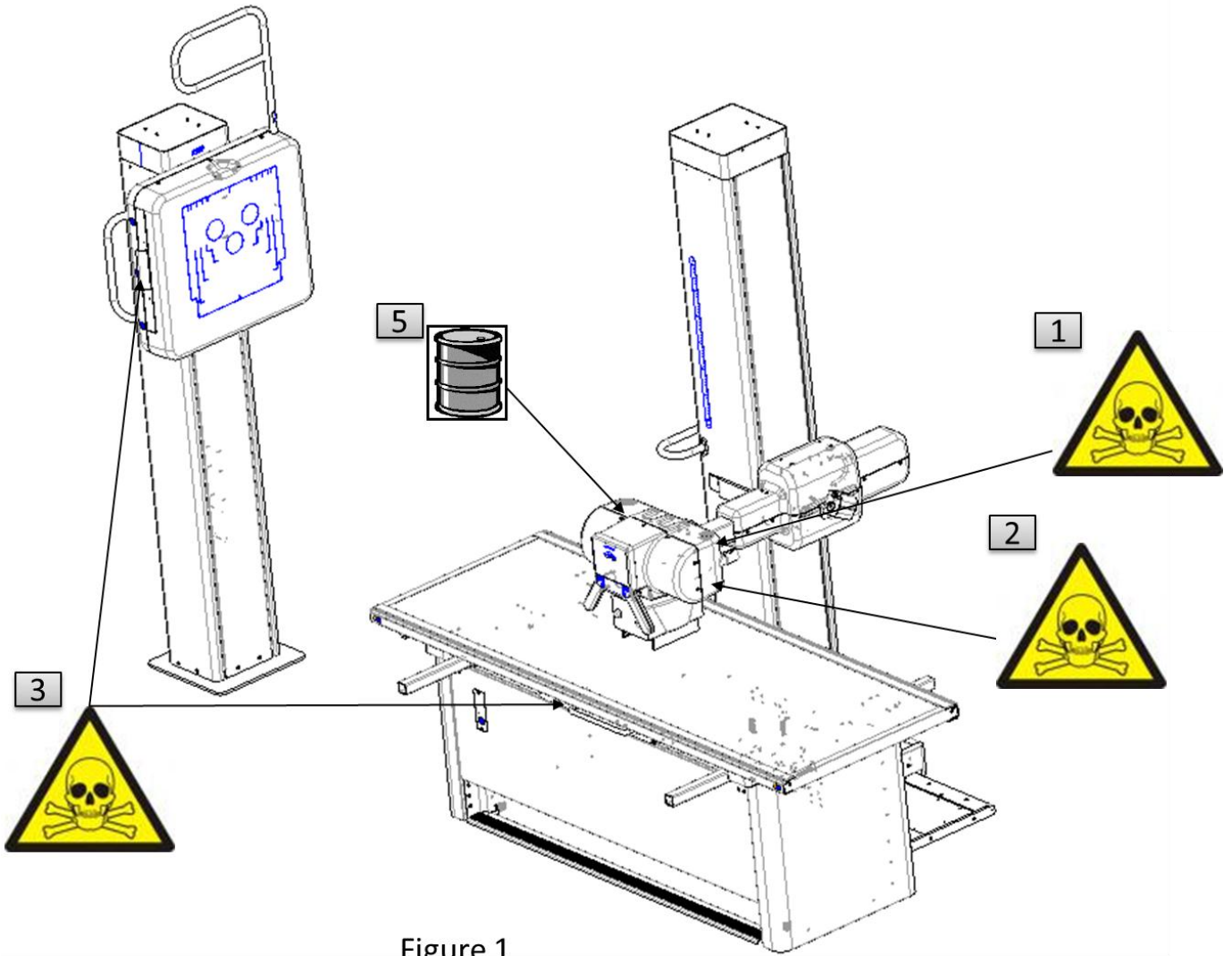
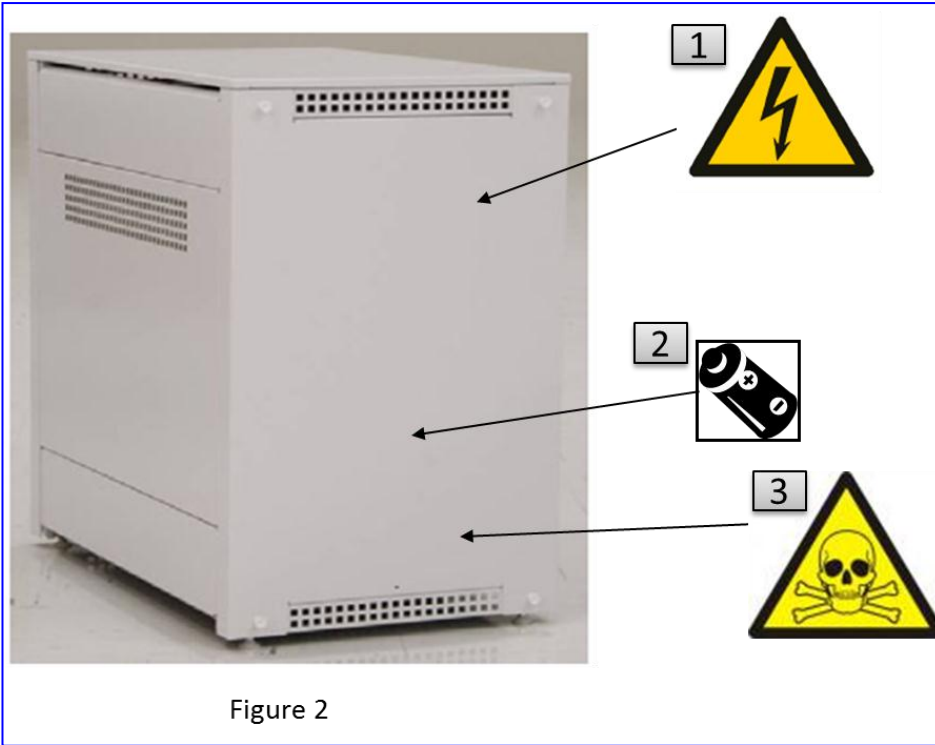

Figure 1



Recycling Passport Revision History

Rev	Description	Reason for Change CR/PR ID #	Date
0	Initial Release	--	14th April 2014