DICOM

Conformance Statement

Digital Diagnost
Release 1.4



Issued by:

Philips Medical Systems Nederland B.V.
Medical IT, Interoperability

Building QV-282
P.O. Box 10.000
5680 DA Best
The Netherlands

email: dicom@philips.com
Internet: <http://www.medical.philips.com/>

Document Number: 4512 1313 5791
Date: 2 May 2005

1. DICOM CONFORMANCE STATEMENT OVERVIEW

This document is the DICOM Conformance Statement for the Philips Medical Systems Digital Diagnost Release 1.4, later referred to as Digital Diagnost.

The Digital Diagnost modality is a digital X-ray image generating system (DICOM image type is 'CR'). It contains an export function based on the DICOM image storage to transfer image data from the Digital Diagnost system to a remote system. This DICOM export function and other functions of Digital Diagnost are described in this document.

Digital Diagnost in a DICOM network

The figure below shows the position of Digital Diagnost in a radiology environment.

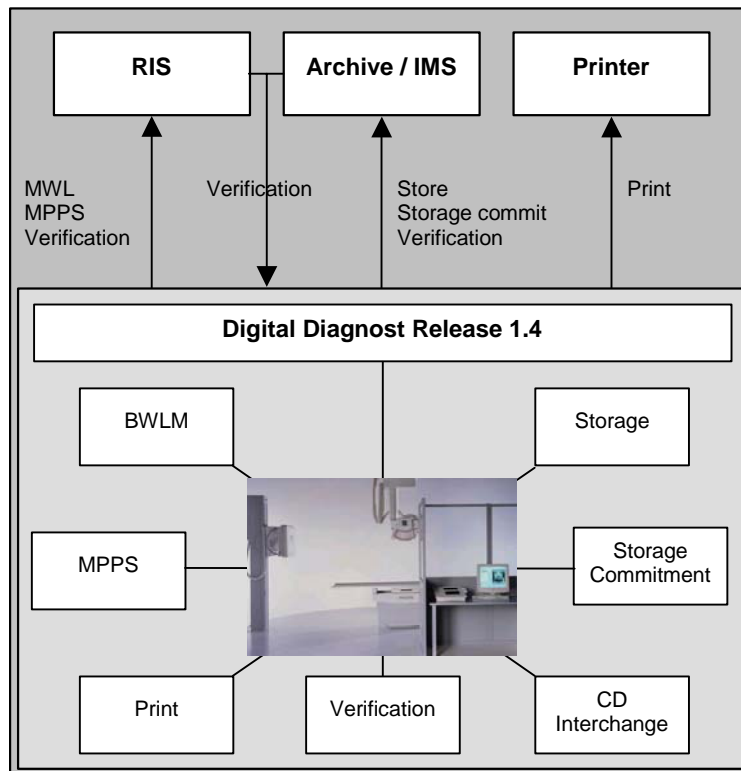

Figure 1: Digital Diagnost in a DICOM network

Digital Diagnost is an embedded modality system for DICOM images. It provides, among other things, the following features:

- Verification of application level communication.
- Basic Worklist Management (BWLM).
- Storage of images on a remote DICOM system.
- Commitment of stored images on a remote DICOM system (Push Model).
- Study Management per Modality Performed Procedure Step (MPPS).
- Storage and retrieval of images per DICOM media (CD-R).
- Printing of hardcopies on a remote DICOM printer.

Table 1: Network Services

SOP Class		User of Service (SCU)	Provider of Service (SCP)
Name	UID		
Transfer			
Computed Radiography Image Storage	1.2.840.10008.5.1.4.1.1.1	Option ¹	No
Workflow Management			
Storage Commitment Push Model	1.2.840.10008.1.20.1	Option ¹	No
Modality Performed Procedure Step	1.2.840.10008.3.1.2.3.3	Option ²	No
Modality Worklist Information Model – FIND	1.2.840.10008.5.1.4.31	Option ²	No
Print Management			
Basic Grayscale Print Management (Meta)	1.2.840.10008.5.1.1.9	Option ²	No
> Basic Film Session	1.2.840.10008.5.1.1.1	Yes ³	No
> Basic Film Box	1.2.840.10008.5.1.1.2	Yes ³	No
> Basic Grayscale Image Box	1.2.840.10008.5.1.1.4	Yes ³	No
> Printer	1.2.840.10008.5.1.1.16	Yes ³	No

The following table lists the supported media storage Application Profiles (with roles).

Table 2: Media Services

Media Storage Application Profile	Write Files (FSC or FSU)	Read Files (FSR)
Compact Disk - Recordable		
General Purpose CD-R	Option ²	Option ²

Note:

1. The storage service is configurable.
2. These optional services can be purchased separately.
3. These services are provided for the Print Management Meta SOP class.

2. TABLE OF CONTENTS

1.	DICOM CONFORMANCE STATEMENT OVERVIEW	3
2.	TABLE OF CONTENTS	5
3.	INTRODUCTION	7
3.1.	Revision History.....	7
3.2.	Audience.....	7
3.3.	Remarks	7
3.4.	Definitions, Terms and Abbreviations	8
3.5.	References	9
4.	NETWORKING.....	10
4.1.	Implementation model	10
4.1.1.	Application Data Flow	10
4.1.2.	Functional Definition of AE's	11
4.1.2.1.	Functional Definition of Digital Diagnost AE	11
4.1.3.	Sequencing of Real World Activities.....	13
4.2.	AE Specifications.....	16
4.2.1.	Digital Diagnost AE	16
4.2.1.1.	SOP Classes.....	16
4.2.1.2.	Association Policies	16
4.2.1.3.	Association Initiation Policy.....	17
4.2.1.4.	Association Acceptance Policy	38
4.3.	Network Interfaces.....	42
4.3.1.	Physical Network Interface	42
4.3.2.	Additional Protocols	42
4.3.2.1.	NTP	42
4.4.	Configuration	43
4.4.1.	AE Title/Presentation Address Mapping	43
4.4.1.1.	Local AE Titles	43
4.4.1.2.	Remote AE Title/Presentation Address Mapping	43
4.4.2.	Parameters.....	43
5.	MEDIA INTERCHANGE.....	46
5.1.	Implementation Model	46
5.1.1.	Application Data Flow Diagram.....	46
5.1.2.	Functional Definitions of AE's	46
5.1.2.1.	Functional Definition of Digital Diagnost AE	46
5.1.3.	Sequencing of Real World Activities.....	47
5.1.4.	File Meta Information for Implementation Class and Version.....	47
5.2.	AE Specifications.....	48
5.2.1.	Digital Diagnost AE	48
5.2.1.1.	File Meta Information for the Digital Diagnost AE	48
5.2.1.2.	Real-World Activities	48
5.3.	Augmented and Private Application Profiles	49
5.3.1.	Augmented Application Profiles	49
5.3.2.	Private Application Profiles	49
5.4.	Media Configuration	49
6.	SUPPORT OF CHARACTER SETS	51
7.	SECURITY	52
8.	ANNEXES.....	53
8.1.	IOD Contents.....	53
8.1.1.	Created SOP Instances	53
8.1.1.1.	Media Storage Directory Storage SOP Class.....	53
8.1.1.2.	Storage Commitment Push Model SOP Class	55
8.1.1.3.	Modality Performed Procedure Step SOP Class – N-CREATE	55
8.1.1.4.	Modality Performed Procedure Step SOP Class – N-SET	58

8.1.1.5.	Basic Film Session SOP Class	61
8.1.1.6.	Basic Film Box SOP Class.....	61
8.1.1.7.	Basic Grayscale Image Box SOP Class	62
8.1.1.8.	Printer SOP Class	62
8.1.1.9.	Computed Radiography Image Storage SOP Class.....	63
8.1.1.10.	Modality Worklist Information Model – FIND SOP Class	74
8.1.2.	Usage of Attributes from Received IOD's	77
8.1.3.	Attribute Mapping	77
8.1.4.	Coerced/Modified fields.....	78
8.2.	Data Dictionary of Private Attributes	78
8.3.	Coded Terminology and Templates	80
8.4.	Grayscale Image consistency	80
8.5.	Standard Extended/Specialized/Private SOPs	80
8.5.1.	Computed Radiography Image Storage SOP Class.....	80
8.6.	Private Transfer Syntaxes	80

3. INTRODUCTION

3.1. Revision History

The revision history provides dates and differences of the different releases.

Table 3: Revision History

Document Version	Date of Issue	Author	Description
1.0	30 September 2004	PMS MIT-IO	Final version for the DICOM Conformance Statement of the Digital Diagnost 1.4
1.1	20 January 2005	PMS MIT-IO	Correction of dosis calculation.
1.2	18 March 2005	PMS MIT-IO	Correction of MPPS settings.
1.3	02 May 2005	PMS MIT-IO	Add Printer status tables

3.2. Audience

This Conformance Statement is intended for:

- (potential) customers
- system integrators of medical equipment
- marketing staff interested in system functionality
- software designers implementing DICOM interfaces

It is assumed that the reader is familiar with the DICOM standard.

3.3. Remarks

The DICOM Conformance Statement is contained in chapters 4 through 8 and follows the contents and structuring requirements of DICOM PS 3.2-XXXX.

This DICOM Conformance Statement by itself does not guarantee successful interoperability of Philips equipment with non-Philips equipment. The user (or user's agent) should be aware of the following issues:

- **Interoperability**
Interoperability refers to the ability of application functions, distributed over two or more systems, to work successfully together. The integration of medical devices into an IT environment may require application functions that are not specified within the scope of DICOM. Consequently, using only the information provided by this Conformance Statement does not guarantee interoperability of Philips equipment with non-Philips equipment. It is the user's responsibility to analyze thoroughly the application requirements and to specify a solution that integrates Philips equipment with non-Philips equipment.
- **Validation**
Philips equipment has been carefully tested to assure that the actual implementation of the DICOM interface corresponds with this Conformance Statement. Where Philips equipment is linked to non-Philips equipment, the first step is to compare the relevant Conformance Statements. If the Conformance Statements indicate that successful information exchange should be possible,

additional validation tests will be necessary to ensure the functionality, performance, accuracy and stability of image and image related data. It is the responsibility of the user (or user's agent) to specify the appropriate test suite and to carry out the additional validation tests.

- **New versions of the DICOM Standard**
The DICOM Standard will evolve in future to meet the user's growing requirements and to incorporate new features and technologies. Philips is actively involved in this evolution and plans to adapt its equipment to future versions of the DICOM Standard. In order to do so, Philips reserves the right to make changes to its products or to discontinue its delivery.
The user should ensure that any non-Philips provider linking to Philips equipment also adapts to future versions of the DICOM Standard. If not, the incorporation of DICOM enhancements into Philips equipment may lead to loss of connectivity (in case of networking) and incompatibility (in case of media).

3.4. Definitions, Terms and Abbreviations

DICOM definitions, terms and abbreviations are used throughout this Conformance Statement. For a description of these, see NEMA PS 3.3-XXXX and PS 3.4-XXXX. The word Philips in this document refers to Philips Medical Systems.

The following acronyms and abbreviations may be used in this document.

ACR	American College of Radiology
AE	Application Entity
ANSI	American National Standard Institute
AP	Application Profile
BWLM	Basic Worklist Management
CD	Compact Disc
CD-R	CD-Recordable
CR	Computed Radiography
DICOM	Digital Imaging and Communications in Medicine
DIMSE	DICOM Message Service Element
DIMSE-C	DIMSE-Composite
DIMSE-N	DIMSE-Normalized
DX	Digital X-Ray
EBE	DICOM Explicit VR Big Endian
ELE	DICOM Explicit VR Little Endian
FSC	File-set Creator
FSR	File-set Reader
FSU	File-set Updater
GUI	Graphic User Interface
HIS	Hospital Information System
HL7	Health Level Seven
ILE	DICOM Implicit VR Little Endian
IOD	Information Object Definition
MOD	Magneto-Optical Disk
MPPS	Modality Performed Procedure Step
NEMA	National Electrical Manufacturers Association
PCR	Philips Computed Radiography
PDU	Protocol Data Unit
RIS	Radiology Information System
RWA	Real-World Activity
SCP	Service Class Provider

SCU	Service Class User
SOP	Service Object Pair
TCP/IP	Transmission Control Protocol/Internet Protocol
UID	Unique Identifier
WLM	Worklist Management

3.5. References

- [DICOM] Digital Imaging and Communications in Medicine (DICOM), Part 1 – 16 (NEMA PS 3.1-XXXX – PS 3.16-XXXX), National Electrical Manufacturers Association (NEMA) Publication Sales 1300 N. 17th Street, Suite 1847 Rosslyn, Virginia. 22209, United States of America

4. NETWORKING

4.1. Implementation model

The implementation model consists of three sections:

- the application data flow diagram, specifying the relationship between the Application Entities and the “external world” or Real-World Activities,
- a functional description of each Application Entity, and
- the sequencing constraints among them.

4.1.1. Application Data Flow

The Digital Diagnost system consists of one single application entity only: the Digital Diagnost Application Entity (Digital Diagnost AE).

Figure 2 shows the Networking application data flow as a functional overview of the Digital Diagnost AE.

It incorporates the following functionality.

- The Digital Diagnost AE can verify application level communication by using the Verification service both as SCU and SCP.
- The Digital Diagnost AE can request a worklist by using the Basic Worklist Management service as SCU.
- The Digital Diagnost AE can store images by using the Storage service as SCU.
- The Digital Diagnost AE can request storage commitment for images by using the Storage Commitment service as SCU.
- The Digital Diagnost AE can compose the modality performed procedure step by using the Study Management service as SCU.
- The Digital Diagnost AE can print images by using the Print Management service as SCU.

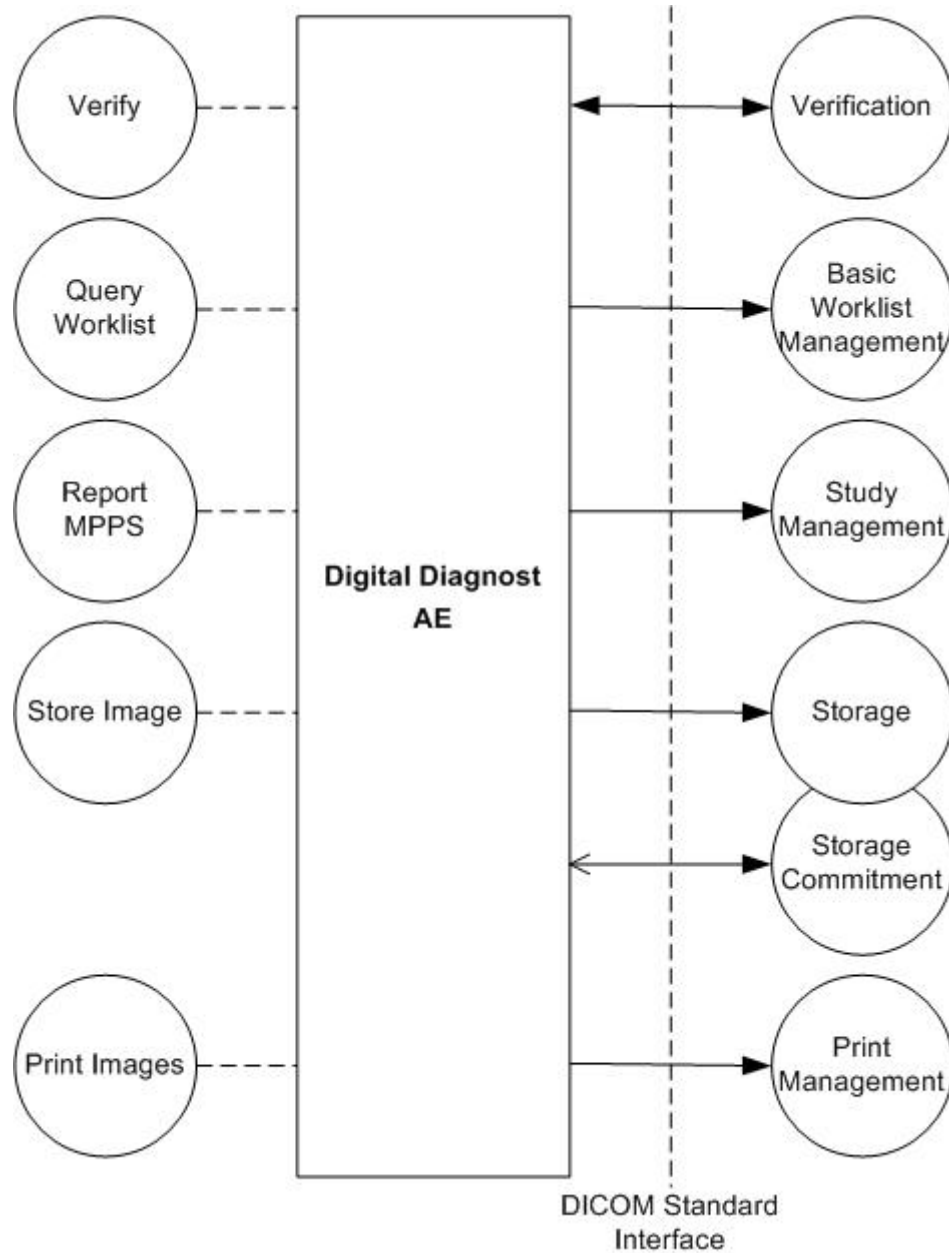

Figure 2: Application Data Flow Diagram

4.1.2. Functional Definition of AE's

This section shall describe in general terms the functions to be performed by the AE, and the DICOM services used to accomplish these functions.

4.1.2.1. Functional Definition of Digital Diagnost AE

The Digital Diagnost AE is the one and only application entity within the Digital Diagnost. It includes the following service classes.

Verification Service Class

The Digital Diagnost AE provides the Verification service as SCP (RWA Verify).

A remote SCU shall request an association with the Digital Diagnost AE for Verification SOP class. After accepting the association the Digital Diagnost AE shall receive and respond to the Verification request and release the association when requested.

The Digital Diagnost AE may use the Verification service as SCU (RWA Verify).

After initiating the Verify, the Digital Diagnost AE shall request an association with the selected remote SCP for the Verification SOP class. After accepting the association the Digital Diagnost AE shall send the verify request, wait for response, and then release the association.

The user interface shall inform on the status of the verification.

Basic Worklist Management Service Class

The Digital Diagnost AE may use the Basic Worklist Management service as SCU (RWA Query Worklist).

After initiating the worklist query the Digital Diagnost AE shall request an association with the configured remote Basic Worklist Management SCP. After accepting the association the Digital Diagnost AE shall send the find request, wait for response, and then release the association.

The user interface shall be updated with the query results.

Storage Service Class

The Digital Diagnost AE may use the Storage service as SCU (RWA Store Image).

After a performed procedure step the Digital Diagnost AE shall store the related images at the configured Storage SCP. It shall request an association with the remote Storage SCP for the applicable Storage SOP classes. After accepting the association the Digital Diagnost AE shall send the store request, wait for response, and then release the association.

Depending on the status of the store and the configuration the Digital Diagnost AE may retry to store images.

After successful storage the user interface shall be updated accordingly.

Storage Commitment Service Class

The Digital Diagnost AE may use the Storage Commitment service as SCU (RWA Commit Image).

If storage commitment is configured then, after Store images, the Digital Diagnost AE shall automatically request commitment of images at the configured Storage Commitment SCP. It shall request an association with the remote Storage Commitment SCP for the Storage Commitment SOP class. After accepting the association the Digital Diagnost AE shall send the action request, wait for response, and then release the association. Depending on the configuration the storage commitment report may be received either synchronous or asynchronous.

Depending on the status of the action and the configuration the Digital Diagnost AE may retry to commit an image.

Study Management Service Class

The Digital Diagnost AE may use the Study Management service as SCU (RWA Create Performed Procedure Step and RWA Set Performed Procedure Step).

After performing a procedure step the Digital Diagnost AE shall request an association with the configured remote Study Management SCP. After accepting the association the Digital Diagnost AE shall send a create request, wait for response, and then release the association.

Next the Digital Diagnost AE shall request a new association to send a set request, and after response, release the association.

Depending on the status of create and set and the configuration the Digital Diagnost AE may perform a retry.

The user interface shall be updated with the performed procedure step status.

4.1.3. Sequencing of Real World Activities

The following sequences of Real-World activities are supported by the system.

Broad Query

The system requests a Worklist (initiates a BWLM request) either by the background "Broad Query" option or issued by the operator. If the query has been initiated by the operator, a result notification is given back. The user selects a patient from the patient list GUI and opens the Examination GUI.

Patient Query (optional)

The user requests a patient oriented worklist by entering matching values in the Patient Query GUI. After the patient related worklist items have been returned, the system directly opens the Examination GUI with the patient's examination context.

Default Acquisitions (Examination GUI)

The user starts the examination. When the user confirms the first acquisition of an examination, the Digital Diagnost sets the MPPS status to "IN PROGRESS" and a DICOM N-CREATE message is sent to the RIS. At the same time the acquisition images may be sent from the Digital Diagnost to the configured archive and printer – as specified in the Examination GUI. If configured, a storage commitment request will be sent to the remote archive too. When the examination has been performed and the user returns to the patient list menu, an MPPS N-SET message (with status COMPLETED or DISCONTINUED) is sent to the RIS.

Re-Processing Acquisitions (Viewer GUI)

If images of an examination have to be re-processed and re-exported with different post-processing, the user selects the images of the patient's examination in the Viewing tool GUI. When a new post-processing of the first image of an examination is confirmed by the user then the system sets the MPPS status to "IN PROGRESS" and a DICOM N-CREATE message is sent to the RIS. At the same time the acquisition images, being new instances of this examination, may be sent from the Digital Diagnost to the configured archive and printer – as specified in the Examination GUI. If configured, a storage commitment request will be sent to the remote archive too. When all intended images of an examination have been re-processed and confirmed and the user goes back to the patient list menu, an MPPS N-SET command (with status COMPLETED) is sent to the RIS.

Processing PCR Acquisitions

Digital Diagnost supports the optional reading and processing of PCR plates. The user starts a patient examination and either:

- registers the PCR plate's ID, takes the acquisition on a non-digital Registration Device (Free RGDV or e.g. a conventional wall stand) and reads the image from the attached PCR cassette reader; or:
- reads the image (that has been acquired by a different system) from the attached PCR cassette reader and links it to the selected examination.

Once the image data has been transferred from the reader to the Digital Diagnost system, the workflow is the same as with native digital acquisitions:

When the user confirms the first acquisition of the examination, the Digital Diagnost sets the MPPS status to "IN PROGRESS" and a DICOM N-CREATE message is sent to the RIS. At the same time the acquisition images may be sent from the Digital Diagnost to the configured archive and printer – as specified in the Examination GUI. If configured, a storage commitment request will be sent to the remote archive too. When the examination has been performed and the user returns to the patient list menu, an MPPS N-SET message (with status COMPLETED or DISCONTINUED) is sent to the RIS.

Taking Non-Digital Acquisitions

The user starts an examination with acquisitions on the non-digital Registration Device (using conventional cassettes). When the acquisitions have been performed and the user goes back to the patient list menu, the system sets the MPPS status to "IN PROGRESS" and a DICOM N-CREATE message is sent back to the RIS, immediately followed by a MPPS N-SET command (with status COMPLETED or DISCONTINUED).

The MPPS messages show an empty referenced image sequence. No images can be sent from Digital Diagnost to a remote DICOM system.

Figure 3 shows a typical sequence of an examination using a worklist.

- The user updates the worklist (Query Worklist) and then selects and opens an examination.
- After the user started the examination and confirmed the first acquisition (image (1)), the RIS is notified (Create Performed Procedure Step) and per default the image is sent to archive (Store Image and – if configured – Commit Image) and printer (Print Image) – all simultaneously.
- Any following acquisitions (image (n)) are sent to archive and printer – again simultaneously.
- Finally, when closing the examination, the RIS is notified to update the data of the examination (Set Performed Procedure Step).

Note that Print Image will send images to the printer only when enough images were received to fulfill the configured print format or when the print job is flushed manually. When the last image of an examination is received the print job will be flushed automatically.

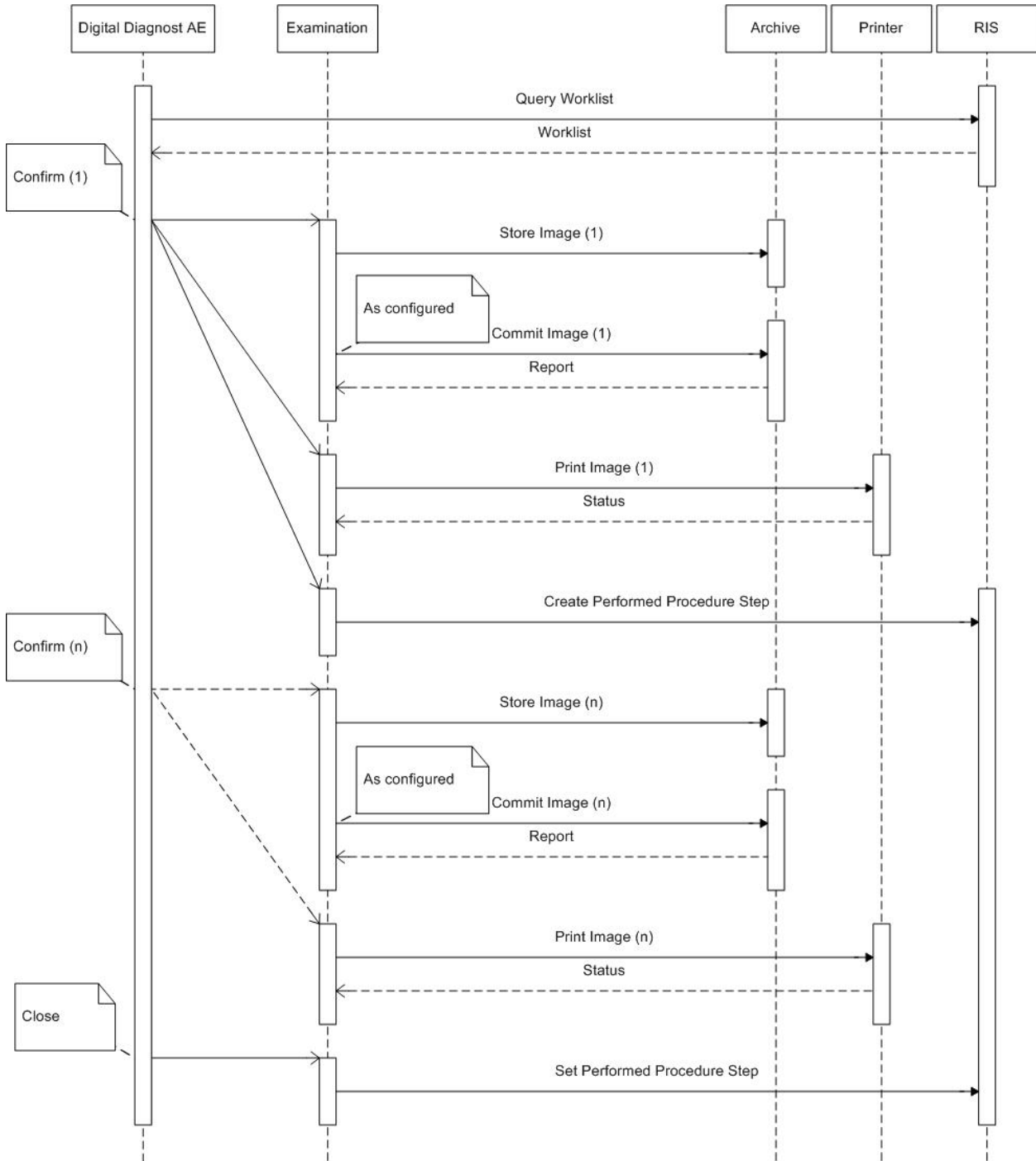

Figure 3: Sequencing of an examination

4.2. AE Specifications

The next section in the DICOM Conformance Statement contains the specification of the one and only Digital Diagnost application entity: Digital Diagnost AE.

4.2.1. Digital Diagnost AE

Every detail of this specific Application Entity shall be completely specified under this section.

4.2.1.1. SOP Classes

This Application Entity provides standard conformance to the following SOP Classes.

Table 4: SOP Classes for Digital Diagnost AE

SOP Class Name	SOP Class UID	SCU	SCP
Verification	1.2.840.10008.1.1	Yes	Yes
Storage Commitment Push Model	1.2.840.10008.1.20.1	Yes	No
Modality Performed Procedure Step	1.2.840.10008.3.1.2.3.3	Yes	No
Computed Radiography Image Storage	1.2.840.10008.5.1.4.1.1.1	Yes	No
Modality Worklist Information Model – FIND	1.2.840.10008.5.1.4.31	Yes	No
Basic Grayscale Print Management (Meta)	1.2.840.10008.5.1.1.9	Yes	No
> Basic Film Session	1.2.840.10008.5.1.1.1	Yes	No
> Basic Film Box	1.2.840.10008.5.1.1.2	Yes	No
> Basic Grayscale Image Box	1.2.840.10008.5.1.1.4	Yes	No
> Printer	1.2.840.10008.5.1.1.16	Yes	No

4.2.1.2. Association Policies

This section shall contain a description of the general association establishment and acceptance policies of the AE.

4.2.1.2.1. General

The DICOM standard application context shall be specified.

Table 5: DICOM Application Context

Application Context Name	1.2.840.10008.3.1.1.1
--------------------------	-----------------------

4.2.1.2.2. Number of Associations

The Digital Diagnost AE will attempt to establish one association per applicable SOP class at a time, hence the following numbers.

Table 6: Number of Associations as Association Initiator

Maximum number of simultaneous associations	5
---------------------------------------------	---

Table 7: Number of Associations as Association Acceptor

Maximum number of simultaneous associations	1
---------------------------------------------	---

4.2.1.2.3. Asynchronous Nature

Digital Diagnost does not support asynchronous operations and will not perform asynchronous window negotiation.

Table 8: Asynchronous Nature as Association Initiator

Maximum number of outstanding asynchronous transactions	N/A
---------------------------------------------------------	-----

4.2.1.2.4. Implementation Identifying Information

Following Implementation Class UID and Version Name are defined.

Table 9: DICOM Implementation Class and Version for Digital Diagnost AE

Implementation Class UID	1.3.46.670589.26.1.4
Implementation Version Name	DigiDiagnost1.4

4.2.1.3. Association Initiation Policy

The Digital Diagnost AE shall initiate associations as a result of the following events.

- The operator clicks the Verify button to initiate a verification (ref. par. 4.2.1.3.1).
- The operator clicks the Worklist Query button to initiate a worklist query (ref. par. 4.2.1.3.2).
- The operator clicks the Confirm button to store (and commit) an exam and create the performed procedure step (ref. par. 4.2.1.3.3 and 4.2.1.3.4).
- The operator clicks the Patient List button to end the examination and set the performed procedure steps (ref. par. 4.2.1.3.4).
- The operator clicks the Patient List button to end the examination and print the exam, or clicks the Print Now button to print an exam (ref. par. 4.2.1.3.5).

The behavior of the AE during association rejection is summarized in Table 10.

Table 10: DICOM Association Rejection Handling

Result	Source	Reason/Diagnosis	Behavior
1 – rejected-permanent	1 – DICOM UL service-user	1 – no-reason-given	The user is notified (via pop-up). If applicable the command will be retried. Log entry.
		2 – application-context-name-not-supported	The user is notified (via pop-up). If applicable the command will be retried. Log entry.
		3 – calling-AE-title-not-recognized	The user is notified (via pop-up). If applicable the command will be retried. Log entry.
		7 – called-AE-title-not-recognized	The user is notified (via pop-up). If applicable the command will be retried. Log entry.
	2 – DICOM UL service-provider (ACSE related function)	1 – no-reason-given	The user is notified (via pop-up). If applicable the command will be retried. Log entry.
		2 – protocol-version-not-supported	The user is notified (via pop-up). If applicable the command will be retried. Log entry.
	3 – DICOM UL service-provider (presentation related function)	1 – temporary-congestion	The user is notified (via pop-up). If applicable the command will be retried. Log entry.
2 – local-limit-exceeded		The user is notified (via pop-up). If applicable the command will be retried. Log entry.	

Result	Source	Reason/Diagnosis	Behavior
2 – rejected-transient	1 – DICOM UL service-user	1 – no-reason-given	The user is notified (via pop-up). If applicable the command will be retried. Log entry.
		2 – application-context-name-not-supported	The user is notified (via pop-up). If applicable the command will be retried. Log entry.
		3 – calling-AE-title-not-recognized	The user is notified (via pop-up). If applicable the command will be retried. Log entry.
		7 – called-AE-title-not-recognized	The user is notified (via pop-up). If applicable the command will be retried. Log entry.
	2 – DICOM UL service-provider (ACSE related function)	1 – no-reason-given	The user is notified (via pop-up). If applicable the command will be retried. Log entry.
		2 – protocol-version-not-supported	The user is notified (via pop-up). If applicable the command will be retried. Log entry.
	3 – DICOM UL service-provider (presentation related function)	1 – temporary-congestion	The user is notified (via pop-up). If applicable the command will be retried. Log entry.
2 – local-limit-exceeded		The user is notified (via pop-up). If applicable the command will be retried. Log entry.	

Note: Retry is only applicable for MPPS, Storage and Print commands.

The behavior of the AE during DICOM command communication failure is summarized in Table 11.

Table 11: DICOM Command Communication Failure Behavior

Exception	Behavior
Timeout	The association is aborted and the command is reported to the user as failed. The reason is logged. If applicable the command will be retried after a configured period of time and up to a configured number of times.
Association aborted	The command is reported to the user as failed. The reason is logged. If applicable the command will be retried after a configured period of time and up to a configured number of times.
Failed to connect	The user is notified (via pop-up). If applicable the command will be retried. Log entry.

4.2.1.3.1. Verify

4.2.1.3.1.1. Description and Sequencing of Activities

When clicking the Verify button the Digital Diagnost AE shall request an association with the selected external device (SCP) for the Verification SOP class. After accepting the association the Digital Diagnost AE shall send the verify request, wait for response, and then release the association.

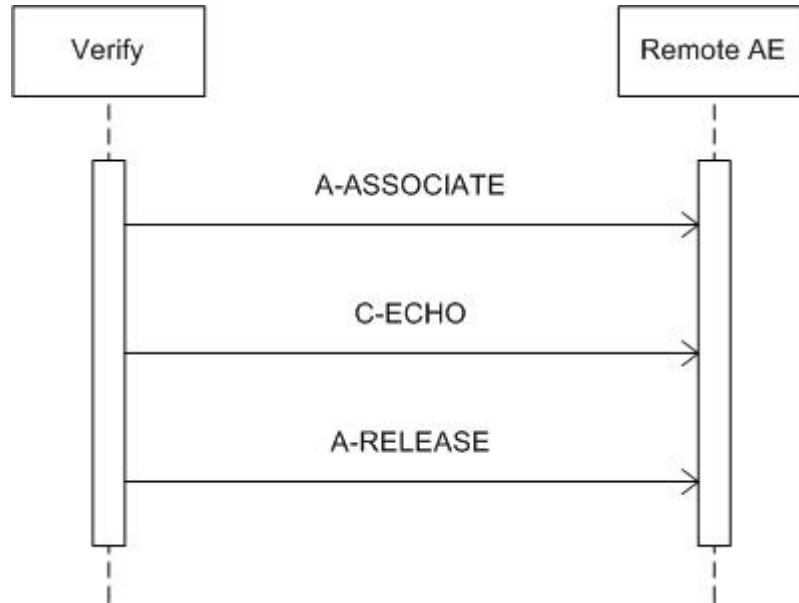

Figure 4: Sequencing of RWA Verify

4.2.1.3.1.2. Proposed Presentation Contexts

The presentation context proposed by the Digital Diagnost AE for Verify is defined in Table 12.

Table 12: Proposed Presentation Context for Verify

Presentation Context Table					
Abstract Syntax		Transfer Syntax		Role	Extended Negotiation
Name	UID	Name List	UID List		
Verification	1.2.840.10008.1.1	EBE ELE ILE	1.2.840.10008.1.2.2 1.2.840.10008.1.2.1 1.2.840.10008.1.2	SCU	None

4.2.1.3.1.3. SOP Specific Conformance for SOP Classes

4.2.1.3.1.3.1. Verification SOP Class

The Digital Diagnost AE provides standard conformance to the DICOM Verification service class.

All details regarding the specific conformance, including response behavior to all status codes, both from an application level and communication errors are provided in Table 13.

Table 13: DICOM C-ECHO Command Response Status Handling Behavior

Service Status	Code	Further Meaning	Behavior
Success	0000	Verification is complete	The SCP has successfully received the verification request.

4.2.1.3.2. Query Worklist

4.2.1.3.2.1. Description and Sequencing of Activities

This RWA may be initiated in two ways.

1. After clicking the Query Worklist button the Digital Diagnost AE shall request an association with the configured remote Basic Worklist Management SCP. When the association is accepted the Digital Diagnost AE shall send the broad query find request, wait for response, and then release the association.
2. After clicking the Patient Query button - entering and confirming the matching key values - the Digital Diagnost AE shall request an association with the configured remote Basic Worklist Management SCP. When the association is accepted the Digital Diagnost AE shall send the patient query find request, wait for response, and then release the association.

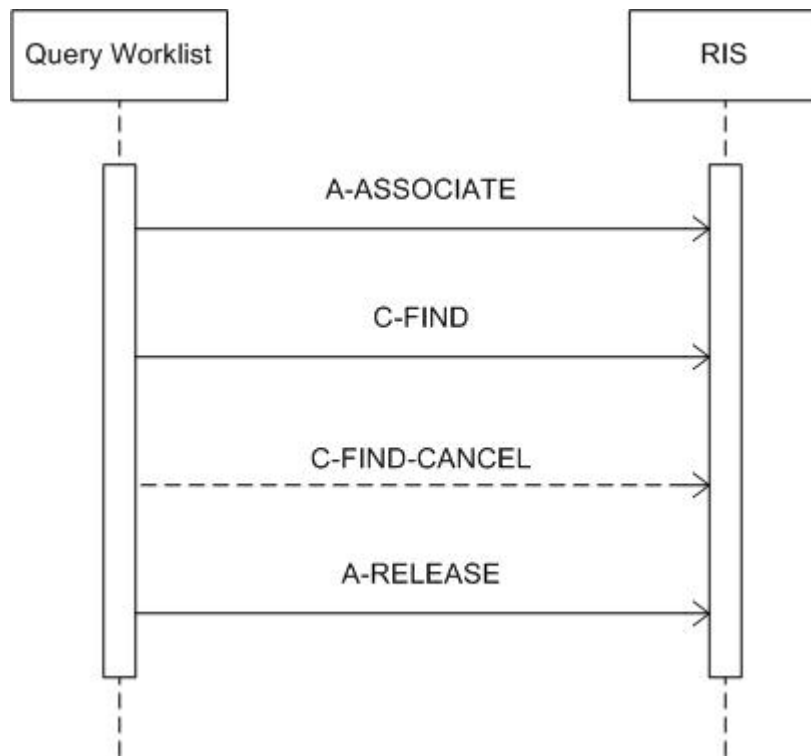

Figure 5: Sequencing of RWA Query Worklist

4.2.1.3.2.1.1. Broad Query

Typically the patient/examination list is updated after a manual Broad Query with pre-configured matching keys. The operator shall initiate the Broad Query from the Patient List user interface. Eventually the operator shall receive a result notification.

Optionally the Broad Query may also be performed automatically in the system background. The time interval between subsequent background queries is configurable. Manual and automatic background queries are serialized and do not interfere with another.

The Broad Query will be cancelled automatically by C-FIND-CANCEL request after a configurable maximum number of returned Worklist items. After cancellation a notification is generated, for possible modification of the query key(s) or the key value(s) or the configured maximum number of Worklist items.

4.2.1.3.2.1.2. Patient Query

Typically the operator shall initiate the optional Patient Query when a patient arrives at the system for examination. Digital Diagnost expects the operator to enter the value(s) of the matching key(s). The matching key entry fields are individually (de)activated per configuration. At least one of the key entry fields must be filled when issuing a query.

4.2.1.3.2.2. Proposed Presentation Contexts

The presentation context proposed by the Digital Diagnost AE for Query Worklist is defined in Table 14.

Table 14: Proposed Presentation Context for Query Worklist

Presentation Context Table					
Abstract Syntax		Transfer Syntax		Role	Extended Negotiation
Name	UID	Name List	UID List		
Modality Worklist Information Model – FIND	1.2.840.10008.5.1.4.31	EBE ELE ILE	1.2.840.10008.1.2.2 1.2.840.10008.1.2.1 1.2.840.10008.1.2	SCU	None

Note that ELE is the preferred transfer syntax.

4.2.1.3.2.3. SOP Specific Conformance for SOP Classes

4.2.1.3.2.3.1. Modality Worklist Information Model – FIND SOP Class

The table below gives an overview of the matching keys for a Broad Query.

Table 15: Matching Keys for a Broad Query

Attribute Name	Tag	Note
Modality	0008,0060	This key may be used if the Worklist is generated for a “modality pool”; although Digital Diagnost always produces CR images, it may query for CR and DX (configurable) images
Scheduled Station AE Title	0040,0001	Digital Diagnost individual AE Title; default matching key
Scheduled Procedure Step Start Date	0040,0002	Configurable one of: date of <today> date of <today> and subsequent dates date of prior to and incl. <today> This key is used combined with AE Title or Modality type.

A virtual Wildcard matching (e.g. “DIDI*”) in Scheduled AE Title may be configured on the Digital Diagnost Application Entity. In this case the DICOM query is performed with universal matching (Scheduled AET value has zero length), and the filtering is done by local means.

The date matching without any other key is not supported. When date matching is configured, the date value is continuously generated from local system time. The

modality type query may be used for environments that do not schedule per individual modality's AE Title, but for a modality pool.

In case of single value matching (e.g. "DIDI_ROOM1"), the returned Scheduled Station AE Title (0040,0001) may contain 1 single value only. The Digital Diagnost AE cannot handle multiple values in this attribute and treats this case as 'not scheduled for local AET'.

The problem can be avoided by Virtual Wildcard Matching (e.g. "DIDI_ROOM*"; this will accept e.g. "DIDI_ROOM1\DIDI_ROOM2"; see explanation above).

The table below gives an overview of the matching keys for a Patient Query.

Table 16: Matching Keys for a Patient Query

Attribute Name	Tag	Note
Accession Number	0008,0040	Identified from admission form or bar-code field
Modality	0008,0060	This key may be optionally added by the system (default: not added). Its value is configurable: CR (default) or DX.
Patient's Name	0010,0010	Identified from admission form or bar code field.
Patient ID	0010,0020	Identified from admission form or bar-code field
Scheduled Station AE Title	0040,0001	This key may be optionally added by the system (default: not added). Its value is the Digital Diagnost individual AE Title or else the optionally configured wildcard expression (e.g. DIDI_ROOM*)
Scheduled Procedure Step Start Date	0040,0002	This key may be optionally added by the system (default: not added). Its configurable value is one of: date of <today> date of <today> and subsequent dates date of prior to and incl. <today>
Requested Procedure ID	0040,1001	Identified from admission form or bar-code field

For Patient's Name wildcard matching support and input format are configurable, i.e.:

- Single field in DICOM notation;
- Two fields (last name, first name).

All details regarding the specific conformance, including response behavior to all status codes, both from an application level and communication errors are provided in Table 17.

Table 17: DICOM C-FIND Command Response Status Handling Behavior

Service Status	Code	Further Meaning	Behavior
Success	0000	Matching is complete	The matching information is shown on the GUI.
Failure	A700	Refused: Out of resources	The user is notified of the query failure (via pop-up). The reason is logged.
	A900	Failed: Identifier does not match SOP class	The user is notified of the query failure (via pop-up). The reason is logged.
	Cxxx	Failed: Unable to process	The user is notified of the query failure (via pop-up). The reason is logged.
Cancel	FE00	Matching terminated due to Cancel request	The matching information is shown on the GUI and the user is notified of the cancellation; log entry.

Service Status	Code	Further Meaning	Behavior
Pending	FF00	Matches are continuing, current match is supplied	Pending status and intermediate number of matches is indicated to the operator.
	FF01	Matches are continuing, warning that one or more optional keys were not supported	Pending status and intermediate number of matches is indicated to the operator.

4.2.1.3.3. Store Image

The storage commitment option of Digital Diagnost requires that storage commitment is configured.

4.2.1.3.3.1. Description and Sequencing of Activities

This RWA may be initiated in two ways.

1. In the viewer, after clicking the Store button the Digital Diagnost AE shall store the selected images at the selected Storage SCP (from the list of configured Storage SCP's).
2. During an examination, after clicking the Confirm button the Digital Diagnost AE shall automatically store the related images of the performed procedure step at the configured Storage SCP.

The Digital Diagnost AE shall request an association with the remote Storage SCP for the applicable Storage SOP classes. After accepting the association the Digital Diagnost AE shall send the store request, wait for response, and then release the association. The store response status may be inspected on the UI. The transferred image shall not be deleted from the system.

Depending on the status of the store and the configuration the Digital Diagnost AE may queue store requests for retry. The queued store requests can be aborted from the UI.

After Store images the Digital Diagnost AE shall automatically request commitment of images at the configured Storage Commitment SCP. For each stored image it shall request a new association with the remote Storage Commitment SCP for the Storage Commitment SOP class.

After accepting the association the Digital Diagnost AE shall send the action request, wait for response, and then release the association. Depending on the configuration the storage commitment report may be received either synchronous or asynchronous. The storage commitment results are displayed in the Patient List ("Number of successful commitments") and in the Viewing tool per single image.

Depending on the status of the action and the configuration the Digital Diagnost AE may retry to commit an image.

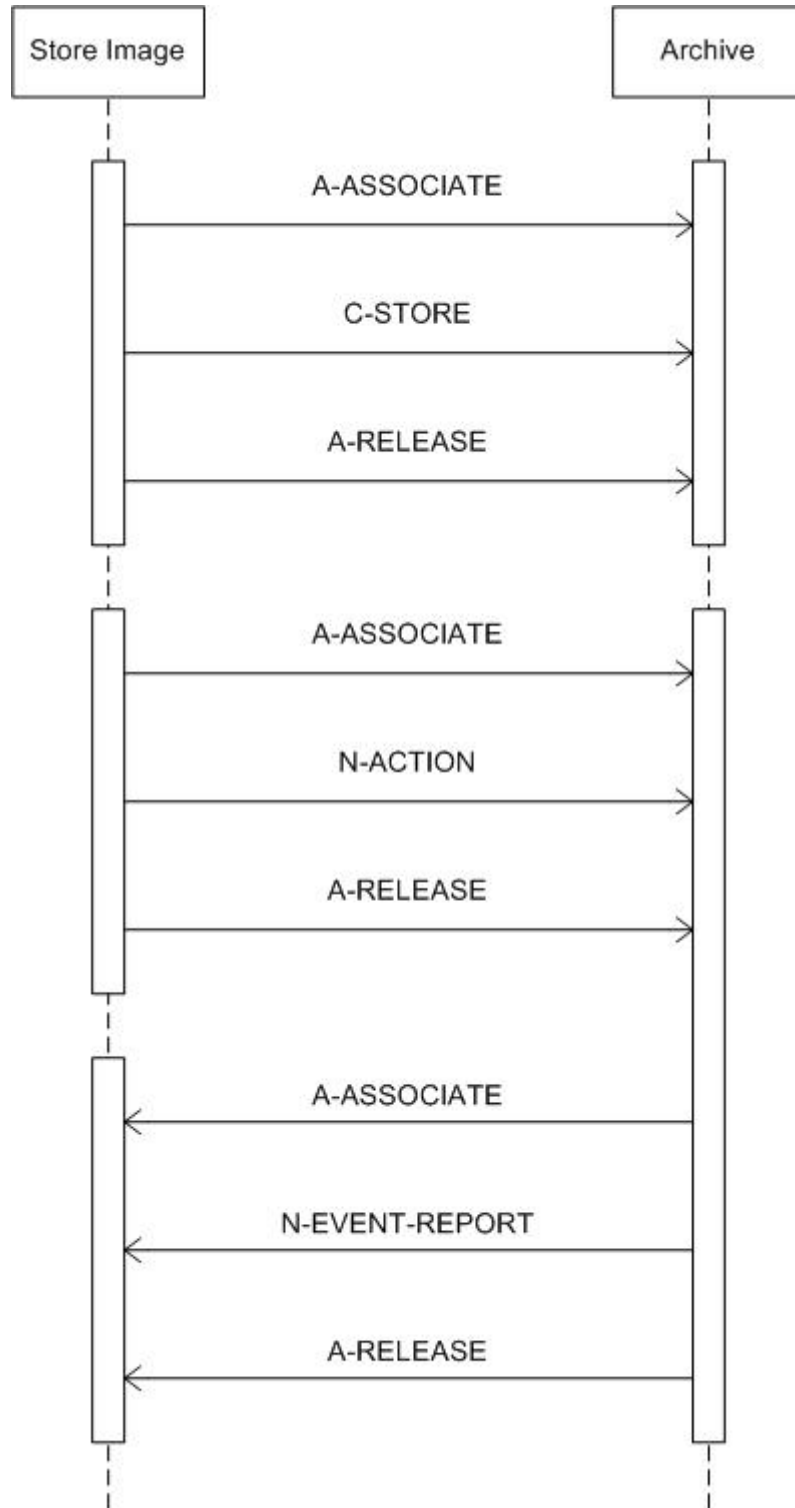

Figure 6: Sequencing of RWA Store Image (asynchronous storage commitment)

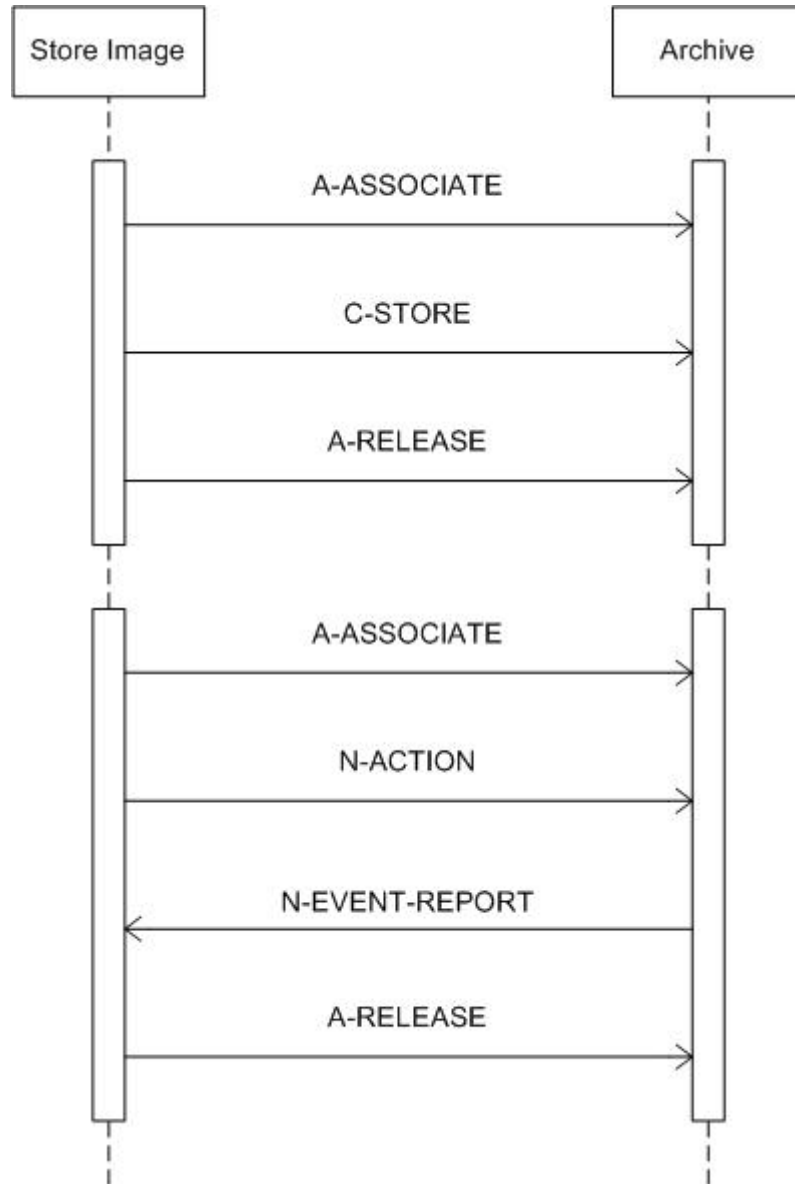

Figure 7: Sequencing of RWA Store Image (synchronous storage commitment)

4.2.1.3.3.2. Proposed Presentation Contexts

The presentation context proposed by the Digital Diagnost AE for Store Image is defined in Table 18.

Table 18: Proposed Presentation Context for Store Image

Presentation Context Table					
Abstract Syntax		Transfer Syntax		Role	Extended Negotiation
Name	UID	Name List	UID List		
Storage Commitment Push Model	1.2.840.10008.1.20.1	EBE ELE ILE	1.2.840.10008.1.2.2 1.2.840.10008.1.2.1 1.2.840.10008.1.2	SCU	None

Presentation Context Table					
Abstract Syntax		Transfer Syntax		Role	Extended Negotiation
Name	UID	Name List	UID List		
Computed Radiography Image Storage	1.2.840.10008.5.1.4.1.1.1	EBE	1.2.840.10008.1.2.2	SCU	None
		ELE	1.2.840.10008.1.2.1		
		ILE	1.2.840.10008.1.2		

Note that ELE is the preferred transfer syntax.

4.2.1.3.3.3. SOP Specific Conformance for SOP Classes

4.2.1.3.3.3.1. Computed Radiography Image Storage SOP Class

All details regarding the specific conformance, including response behavior to all status codes, both from an application level and communication errors are provided in Table 19.

Table 19: DICOM C-STORE Response Status Handling Behavior

Service Status	Code	Further Meaning	Behavior
Success	0000	Storage is complete	Success is logged. The entry is removed from the export queue.
Failure	A7xx	Refused: Out of resources	The user is notified of the archive failure (via pop-up). The reason is logged. After a configured period of time the storage will be retried up to a configured number of times.
	A9xx	Error: Data set does not match SOP class	The user is notified of the archive failure (via pop-up). The reason is logged. After a configured period of time the storage will be retried up to a configured number of times.
	Cxxx	Error: Cannot understand	The user is notified of the archive failure (via pop-up). The reason is logged. After a configured period of time the storage will be retried up to a configured number of times.
Warning	B000	Coercion of data elements	The warning is logged. The entry is removed from the export queue.
	B006	Elements discarded	The warning is logged. The entry is removed from the export queue.
	B007	Data set does not match SOP class	The warning is logged. The entry is removed from the export queue.

The status can be inspected via the user interface.

4.2.1.3.3.3.2. Storage Commitment Push Model SOP Class

All details regarding the specific conformance, including response behavior to all status codes, both from an application level and communication errors are provided in Table 20. The N-EVENT-REPORT handling behavior is specified in section 4.2.1.4.2.

Table 20: DICOM N-ACTION Response Status Handling Behavior

Service Status	Code	Further Meaning	Behavior
Success	0000	Successful operation	The SCP has successfully received the storage commitment action request.
Failure	0110	Processing failure	The user is notified (via pop-up). Retry storage commitment request. Log entry.

Service Status	Code	Further Meaning	Behavior
	0112	No such object instance	The user is notified (via pop-up). Retry store and storage commitment request. Log entry.
	0114	No such argument	The user is notified (via pop-up). No retry. Log entry.
	0115	Invalid argument value	The user is notified (via pop-up). No retry. Log entry.
	0117	Invalid object instance	The user is notified (via pop-up). No retry. Log entry.
	0118	No such SOP class	The user is notified (via pop-up). No retry. Log entry.
	0119	Class-instance conflict	The user is notified (via pop-up). No retry. Log entry.
	0123	No such action type	The user is notified (via pop-up). No retry. Log entry.
	0210	Duplicate invocatio	The user is notified (via pop-up). No retry. Log entry.
	0211	Unrecognized operation	The user is notified (via pop-up). No retry. Log entry.
	0212	Mistyped argument	The user is notified (via pop-up). No retry. Log entry.
	0213	Resource limitation	The user is notified (via pop-up). Retry storage commitment request. Log entry.

4.2.1.3.4. Report MPPS

The MPPS option of Digital Diagnost requires that the Basic Worklist Management option is enabled.

4.2.1.3.4.1. Description and Sequencing of Activities

Description of Activities

A Digital Diagnost Examination is regarded equivalent to a DICOM Procedure Step. It is scheduled or manually entered before an acquisition is taken, and performed by taking acquisitions. Since an examination may be re-opened after having been closed, and each examination workflow context is enclosed in one MPPS, one examination may result in 0 to <n> MPPS instances.

After the first acquisition for a Scheduled Procedure Step has been performed, the system sets the MPPS status of the related examination to "IN PROGRESS" and generates an initial MPPS IN PROGRESS message. The system does not generate intermediate MPPS IN PROGRESS messages for subsequent acquisitions of this Scheduled Procedure Step instance.

Digital Diagnost also generates MPPS IN PROGRESS messages for images that are re-processed by the Viewing tool, i.e. outside an acquisition session. Digital Diagnost does not generate MPPS messages for simple image re-export by the Viewing tool.

After finishing the appropriate acquisition(s) or reprocessing, when returning to the patient list the system will change the MPPS status of the related examination to "COMPLETED" and generate an MPPS COMPLETED message. Digital Diagnost also generates MPPS messages for unscheduled examinations.

The MPPS COMPLETED message will list the UID's of all related DICOM images and the number and format of (optionally) generated prints.

After abandoning or discontinuing a procedure step, the operator may set the MPPS status of the related examination to "DISCONTINUED" and the system generates a MPPS DISCONTINUED message. The reason for abandoning or discontinuing a procedure step is unspecified.

The operator may interchange the performed sequence order of scheduled procedure steps.

MPPS messages may interleave. Depending on the application workflow optimization by the user, an MPPS sequence like this may come up:

MPPS / SOP Instance UID 1: N-CREATE (IN PROGRESS)
MPPS / SOP Instance UID 2: N-CREATE (IN PROGRESS)
MPPS / SOP Instance UID 3: N-CREATE (IN PROGRESS)
...
MPPS / SOP Instance UID 2: N-SET (COMPLETED)
MPPS / SOP Instance UID 1: N-SET (COMPLETED)
MPPS / SOP Instance UID 3: N-SET (COMPLETED)

(i.e.: running multiple procedure steps 'in parallel').

Sequencing of Activities

After storing a performed procedure step the Digital Diagnost AE shall request an association with the configured remote Study Management SCP. After accepting the association the Digital Diagnost AE shall send a Create request, wait for response, and then release the association.

After performing an examination the Digital Diagnost AE shall request an association with the configured remote Study Management SCP. After accepting the association the Digital Diagnost AE shall send a set request, wait for response, and then release the association.

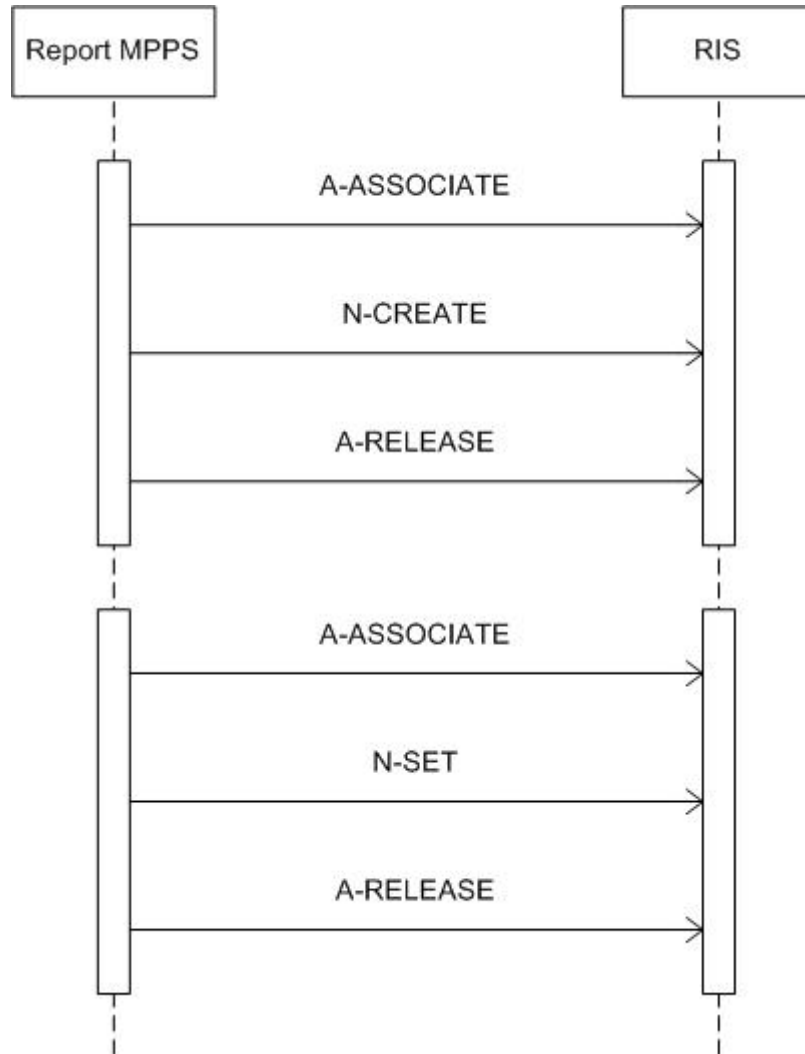

Figure 8: Sequencing of RWA Report MPPS

Depending on the response status and the configuration the Digital Diagnost AE may perform retries.

4.2.1.3.4.2. Proposed Presentation Contexts

The presentation contexts proposed by the Digital Diagnost AE for Report MPPS are defined in Table 21.

Table 21: Proposed Presentation Contexts for Report MPPS

Presentation Context Table					
Abstract Syntax		Transfer Syntax		Role	Extended Negotiation
Name	UID	Name List	UID List		
Modality Performed Procedure Step	1.2.840.10008.3.1.2.3.3	EBE ELE ILE	1.2.840.10008.1.2.2 1.2.840.10008.1.2.1 1.2.840.10008.1.2	SCU	None

Note that ELE is the preferred transfer syntax.

4.2.1.3.4.3. SOP Specific Conformance for SOP Classes

4.2.1.3.4.3.1. Modality Performed Procedure Step SOP Class

When performing the first acquisition of a Scheduled or Unscheduled Procedure Step, Digital Diagnost generates a MPPS IN PROGRESS message. Digital Diagnost does not generate intermediate IN PROGRESS (N-SET) messages and does not support the Performed Procedure Step Exception Management Option. Digital Diagnost has no Billing Code Tables and does not support the Performed Procedure Step Billing and Material Management Option, except data in the Film Consumption Sequence, if optional Print is configured.

If, for application reasons, the operator decides to perform a scheduled (or unscheduled) Procedure Step (= Examination) not on the Digital Detector, but on the attached conventional film cassette, the resulting MPPS messages do not list image references.

If the operator decides to perform a Procedure Step partly by the Digital Detector and partly by the attached conventional film cassette, the result of this Procedure Step, for data consistency reason, is sent by 2 separate MPPS instances: one for the digital part, the other for the conventional part.

An MPPS sequence like this comes up:

MPPS / SOP Instance UID 1 (digital part):	N-CREATE (IN PROGRESS)
MPPS / SOP Instance UID 2 (conventional part):	N-CREATE (IN PROGRESS)
MPPS / SOP Instance UID 1 (digital part):	N-SET (COMPLETED)
MPPS / SOP Instance UID 2 (conventional part):	N-SET (COMPLETED)

Assisted Acquisition Protocol Setting Option

Digital Diagnost by default derives the specific acquisition protocol from the Scheduled Protocol Code Sequence Items. Any single Item results in an Examination. Digital Diagnost supports 3 more (configurable) mapping relations, as shown below:

- Examination is selected from Scheduled Protocol Code Items->Code Value (0040,0008) (default)
- Examination is selected from Scheduled Procedure Step Description (0040,0007)
- Examination is selected from Requested Procedure Code Items->Code Value (0032,1064)
- Examination is selected from Requested Procedure Description (0032,1060)

Digital Diagnost does not evaluate the attributes Coding Scheme Version (0008,0103), Coding Scheme Designator (0008,0102), Code Meaning (0008,0104), but only the Code Value (0008,0100), for mapping the examination settings. I.e. Digital Diagnost expects that any used Code Value is unique (unambiguous) within a given RIS domain.

Per Scheduled Procedure Step, Digital Diagnost is able to accept up to 15 items in the Scheduled Protocol Code Sequence and Requested Procedure Code Sequence, respectively. If more items are sent, the supernumerary items are dropped, and an operator alert is created.

Restrictions Depending on Number of Scheduled Protocol Code Items

If the Scheduled Procedure Step contains only 1 Item in the Scheduled Protocol Code Sequence, there is nothing special, and this case is recommended.

If the Scheduled Procedure Step contains <n> items in the Scheduled Protocol Code Sequence, the Scheduled Procedure Step is split into <n> examinations, where any single examination shows only 1 of the Scheduled Protocol Code Items, but all the other attributes are the same.

When such an examination is returned via MPPS, also the Performed Protocol Code Sequence will show only 1 item. If all <n> Scheduled Procedure Step Code Items are performed, <n> MPPS instances will be sent back to the RIS, and the sum of all Performed Protocol Code Items will be <n>.

All details regarding the specific conformance, including response behavior to all status codes, both from an application level and communication errors are provided in Table 22.

Table 22: DICOM Command Response Status Handling Behavior

Service Status	Code	Further Meaning	Behavior
Success	0000	Successful operation	The SCP has successfully received the modality performed procedure step create request. Log entry.
Failure	0105	No such attribute	The command is reported to the user as failed. The reason is logged. No retry.
	0106	Invalid attribute value	The command is reported to the user as failed. The reason is logged. No retry.
	0110	Processing failure	The command is reported to the user as failed. The reason is logged. No retry.
	0111	Duplicate SOP instance	The command is reported to the user as failed. The reason is logged. No retry.
	0112	No such object instance	The command is reported to the user as failed. The reason is logged. No retry.
	0117	Invalid object instance	The command is reported to the user as failed. The reason is logged. No retry.
	0118	No such SOP class	The command is reported to the user as failed. The reason is logged. No retry.
	0119	Class-instance conflict	The command is reported to the user as failed. The reason is logged. No retry.
	0120	Missing attribute	The command is reported to the user as failed. The reason is logged. No retry.
	0121	Missing attribute value	The command is reported to the user as failed. The reason is logged. No retry.
	0210	Duplicate invocation	The command is reported to the user as failed. The reason is logged. No retry.
	0211	Unrecognized operation	The command is reported to the user as failed. The reason is logged. No retry.
	0212	Mistyped argument	The command is reported to the user as failed. The reason is logged. No retry.
0213	Resource limitation	The command is reported to the user as failed. The reason is logged. After a configured period of time the storage will be retried up to a configured number of times.	

4.2.1.3.5. Print Image

4.2.1.3.5.1. Description and Sequencing of Activities

The RWA Print Image involves the printing of an image by sending the selected image data to a Print Management SCP (i.e. printer).

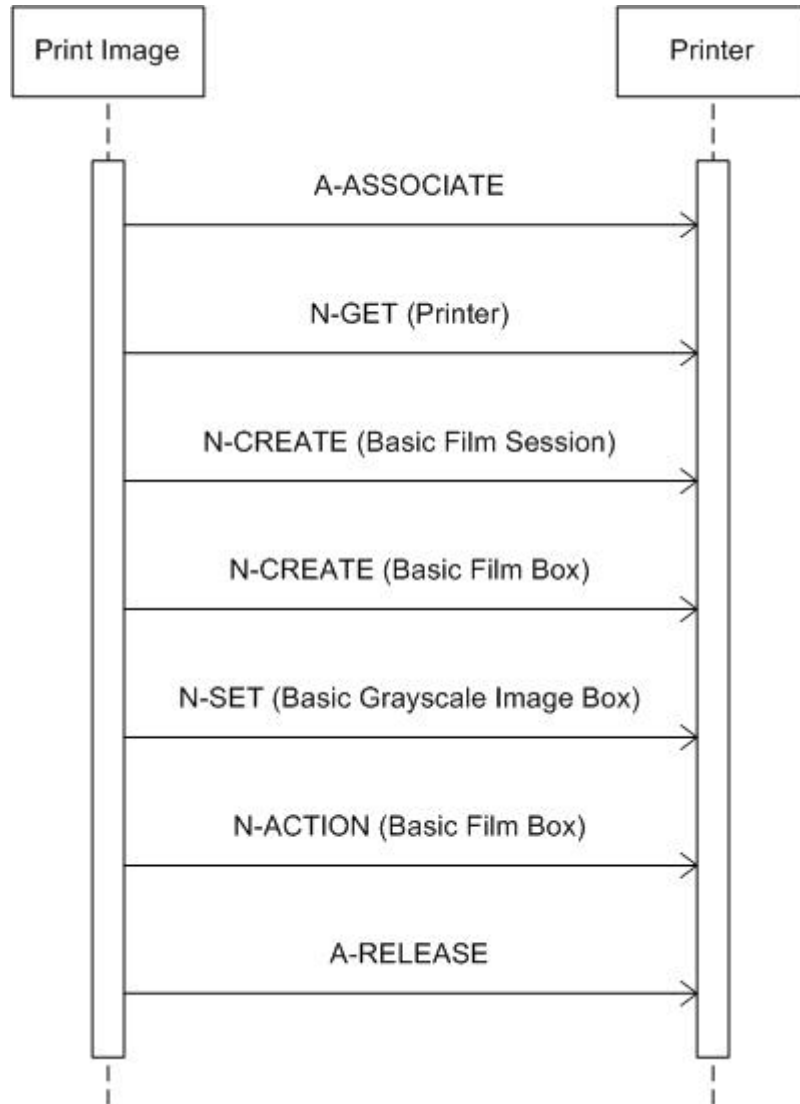

Figure 9: Sequencing of RWA Print Image

The Digital Diagnost AE cannot handle any N-EVENT-REPORT messages.

A print job (film session) comprises one single film box with one single image (that is composed of 1..N modality images).

Print jobs may be generated in two modes:

1. AutoPrint
2. Manual Print.

In AutoPrint mode, (1..N) modality images are composed to one logical film image (film page) according to a preconfigured Examination specific layout (size, orientation, image number, image position, scaling, overlay, annotation and shutter information, etc.).

If a preconfigured layout cannot be used (layout conflict), or the layout cannot be filled then a GUI with a preview pops up. The automatic GUI pop-up can also be forced by configuration.

In Manual Print mode, (1..N) modality images are composed on one film image by manual arrangement of the user, allowing for a print preview.

Depending on the response status of set and the configuration the Digital Diagnost AE may perform a retry.

4.2.1.3.5.2. Proposed Presentation Contexts

The presentation contexts proposed by the Digital Diagnost AE for Print Image are defined in Table 23.

Table 23: Proposed Presentation Contexts for Print Image

Presentation Context Table					
Abstract Syntax		Transfer Syntax		Role	Extended Negotiation
Name	UID	Name List	UID List		
Basic Grayscale Print Management (Meta)	1.2.840.10008.5.1.1.9	ELE	1.2.840.10008.1.2.1	SCU	None
		ILE	1.2.840.10008.1.2		
		EBE	1.2.840.10008.1.2.2		

4.2.1.3.5.3. SOP Specific Conformance for SOP Classes

4.2.1.3.5.3.1. Basic Grayscale Print Management Meta SOP Class

All details regarding the specific conformance, including response behavior to all status codes, both from an application level and communication errors are provided in Table 24 to Table 29.

All failures and warnings of unsolvable problems are treated the same way: the print job fails and is retried. After the configured number of retries the job will be removed from the print queue and added again at the end of the queue. The HCU GUI button then indicates failure (red) until the next job in the queue has succeeded. Jobs failing repeatedly after re-queuing can be deleted manually by the operator.

Table 24: DICOM Command Response Status Handling Behavior for Printer N-GET

Service Status	Code	Further Meaning	Behavior
Success	0000	Successful operation	The print job continues.
Warning	0107	Attribute List Error	The print job fails and is retried.
	0001	Requested optional attributes are not supported	The print job fails and is retried.
Failure	0119	Class instance conflict	The print job fails and is retried.
	0210	Duplicate invocation	The print job fails and is retried.
	0212	Mistyped argument	The print job fails and is retried.
	0118	No such SOP class	The print job fails and is retried.
	0110	Processing failure	The print job fails and is retried.
	0213	Resource limitation	The print job fails and is retried.
	0211	Unrecognized operation	The print job fails and is retried.

Service Status	Code	Further Meaning	Behavior
	0117	Invalid SOP instance	The print job fails and is retried.
	0112	No such SOP instance	The print job fails and is retried.

Table 25: DICOM Command Response Status Handling Behavior for Basic Film Session N-CREATE

Service Status	Code	Further Meaning	Behavior
Success	0000	Successful operation	The print job continues.
Warning	B600	Memory allocation not supported	The print job continues.
Failure	0119	Class instance conflict	The print job fails and is retried.
	0210	Duplicate invocation	The print job fails and is retried.
	0111	Duplicate SOP instance	The print job fails and is retried.
	0106	Invalid attribute value	The print job fails and is retried.
	0120	Missing attribute	The print job fails and is retried.
	0121	Missing attribute value	The print job fails and is retried.
	0212	Mistyped argument	The print job fails and is retried.
	0105	No such attribute	The print job fails and is retried.
	0118	No such SOP class	The print job fails and is retried.
	0110	Processing failure	The print job fails and is retried.
	0213	Resource limitation	The print job fails and is retried.
	0211	Unrecognized operation	The print job fails and is retried.
	0117	Invalid SOP instance	The print job fails and is retried.
	0112	No such SOP instance	The print job fails and is retried.

Table 26: DICOM Command Response Status Handling Behavior for Basic Film Box N-CREATE

Service Status	Code	Further Meaning	Behavior
Success	0000	Successful operation	The print job continues.
Warning	B605	Requested min dens. or max. density outside of printer's operating range. Printer will use its resp. min./max. density instead	The print job continues.
Failure	0119	Class instance conflict	The print job fails and is retried.
	0210	Duplicate invocation	The print job fails and is retried.
	0111	Duplicate SOP instance	The print job fails and is retried.
	0106	Invalid attribute value	The print job fails and is retried.
	0120	Missing attribute	The print job fails and is retried.
	0121	Missing attribute value	The print job fails and is retried.
	0212	Mistyped argument	The print job fails and is retried.
	0105	No such attribute	The print job fails and is retried.
	0118	No such SOP class	The print job fails and is retried.
	0110	Processing failure	The print job fails and is retried.

Service Status	Code	Further Meaning	Behavior
	0213	Resource limitation	The print job fails and is retried.
	0211	Unrecognized operation	The print job fails and is retried.
	C616	There is an existing film box that has not been printed and N-ACTION at the film session level is not supported. A new film box will not be created when a previous film box has not been printed.	The print job fails and is retried.
	0117	Invalid SOP instance	The print job fails and is retried.
	0112	No such SOP instance	The print job fails and is retried.

Table 27: DICOM Command Response Status Handling Behavior for Basic Grayscale Image Box N-SET

Service Status	Code	Further Meaning	Behavior
Success	0000	Successful operation	The print job continues.
Warning	B604	Image size larger than image box, the image has been demagnified.	The print job continues.
Warning	B605	Requested min dens. or max. density outside of printer's operating range. Printer uses its resp. min./max. density instead.	The print job continues.
	B609	Image size is larger than the Image Box size. The image has been cropped to fit.	The print job continues.
	B60A	Image size or combined print image size is larger than the image box size. The image or combined print image has been decimated to fit.	The print job continues.
Failure	0119	Class instance conflict	The print job fails and is retried.
	0210	Duplicate invocation	The print job fails and is retried.
	0106	Invalid attribute value	The print job fails and is retried.
	0212	Mistyped argument	The print job fails and is retried.
	0121	Missing attribute value	The print job fails and is retried.
	0105	No such attribute	The print job fails and is retried.
	0118	No such SOP class	The print job fails and is retried.
	0110	Processing failure	The print job fails and is retried.
	0213	Resource limitation	The print job fails and is retried.
	0211	Unrecognized operation	The print job fails and is retried.
	0117	Invalid SOP instance	The print job fails and is retried.
	0112	No such SOP instance	The print job fails and is retried.
	C603	Image size is larger than image box size	The print job fails and is retried.

Service Status	Code	Further Meaning	Behavior
	C605	Insufficient memory in printer to store the image	The print job fails and is retried.
	C613	Combined print image size is larger than the image box size	The print job fails and is retried.

Table 28: DICOM Command Response Status Handling Behavior for Basic Film Box N-ACTION

Service Status	Code	Further Meaning	Behavior
Success	0000	Successful operation	The print job continues.
Warning	B603	Film Box SOP Instance SOP instances (empty hierarchy does not contain image box page)	The print job continues.
	B604	Image size is larger than image box size, the image has been demagnified.	The print job continues.
	B609	Image size is larger than the image box size. The image has been cropped to fit.	The print job continues.
	B60A	Image size or combined print image size is larger than the image box size. Image or combined print image has been decimated to fit.	The print job continues.
Failure	0119	Class instance conflict	The print job fails and is retried.
	0210	Duplicate invocation	The print job fails and is retried.
	0115	Invalid argument value	The print job fails and is retried.
	0120	Missing attribute	The print job fails and is retried.
	0121	Missing attribute value	The print job fails and is retried.
	0212	Mistyped argument	The print job fails and is retried.
	0105	No such attribute	The print job fails and is retried.
	0118	No such SOP class	The print job fails and is retried.
	0110	Processing failure	The print job fails and is retried.
	0213	Resource limitation	The print job fails and is retried.
	0211	Unrecognized operation	The print job fails and is retried.
	0117	Invalid SOP instance (Invalid object instance)	The print job fails and is retried.
	0112	No such SOP instance (No such object instance)	The print job fails and is retried.
	C602	Unable to create print job SOP instance; print queue is full	The print job fails and is retried.
	C603	Image size is larger than image box size	The print job fails and is retried.
	C613	Combined print image size is larger than the image box size	The print job fails and is retried.

Table 29: DICOM Command Response Status Handling Behavior for Printer N-EVENT-REPORT

Event Type Name	Event Type ID	Behavior
Normal	1	The N-EVENT-REPORT-RSP is sent to the SCP with: Status = 0 Event Type ID = 1 Information is logged. The print job continues.
Warning	2	The N-EVENT-REPORT-RSP is sent to the SCP with: Status = 0 Event Type ID = 2 Warning is logged. The print job continues.
Failure	3	The N-EVENT-REPORT-RSP is sent to the SCP with: Status = 0 Event Type ID = 3 Error is logged. The print job fails and is retried.

The behavior of the AE during communication failure is summarized in Table 30.

Table 30: DICOM Command Communication Failure Behavior

Exception	Behavior
Timeout	The Association is aborted using AP-ABORT and the command is marked as failed. The reason is logged. After a maximum number of retries the user is notified via pop-up (in preview mode only).
Association aborted	The command is marked as failed. The reason is logged. After a maximum number of retries the user is notified via pop-up (in preview mode only).
Failed to connect	Log entry. After a maximum number of retries the user is notified via pop-up (in preview mode only).

4.2.1.4. Association Acceptance Policy

This section describes the conditions under which the AE will accept an association. The AE association rejection policies are summarized in Table 31.

Table 31: DICOM Association Rejection Policies

Result	Source	Reason/Diagnosis	Explanation
1 – rejected-permanent	1 – DICOM UL service-user	1 – no-reason-given	If applicable the command will be retried. Log entry. The user is notified via pop-up (in preview mode only).
		2 – application-context-name-not-supported	If applicable the command will be retried. Log entry. The user is notified via pop-up (in preview mode only).
		3 – calling-AE-title-not-recognized	If applicable the command will be retried. Log entry. The user is notified via pop-up (in preview mode only).
		7 – called-AE-title-not-recognized	If applicable the command will be retried. Log entry. The user is notified via pop-up (in preview mode only).
	2 – DICOM UL service-provider (ACSE related function)	1 – no-reason-given	If applicable the command will be retried. Log entry. The user is notified via pop-up (in preview mode only).
		2 – protocol-version-not-supported	If applicable the command will be retried. Log entry. The user is notified via pop-up (in preview mode only).
	3 – DICOM UL service-provider (presentation related function)	1 – temporary-congestion	If applicable the command will be retried. Log entry. The user is notified via pop-up (in preview mode only).
		2 – local-limit-exceeded	If applicable the command will be retried. Log entry. The user is notified via pop-up (in preview mode only).
2 – rejected-transient	1 – DICOM UL service-user	1 – no-reason-given	If applicable the command will be retried. Log entry. The user is notified via pop-up (in preview mode only).
		2 – application-context-name-not-supported	If applicable the command will be retried. Log entry. The user is notified via pop-up (in preview mode only).
		3 – calling-AE-title-not-recognized	If applicable the command will be retried. Log entry. The user is notified via pop-up (in preview mode only).
		7 – called-AE-title-not-recognized	If applicable the command will be retried. Log entry. The user is notified via pop-up (in preview mode only).
	2 – DICOM UL service-provider (ACSE related function)	1 – no-reason-given	If applicable the command will be retried. Log entry. The user is notified via pop-up (in preview mode only).
		2 – protocol-version-not-supported	If applicable the command will be retried. Log entry. The user is notified via pop-up (in preview mode only).

Result	Source	Reason/Diagnosis	Explanation
	3 – DICOM UL service-provider (presentation related function)	1 – temporary-congestion	If applicable the command will be retried. Log entry. The user is notified via pop-up (in preview mode only).
		2 – local-limit-exceeded	If applicable the command will be retried. Log entry. The user is notified via pop-up (in preview mode only).

4.2.1.4.1. Verify

4.2.1.4.1.1. Description and Sequencing of Activities

The Digital Diagnost AE accepts associations from systems that wish to verify application level communication using the C-ECHO command.

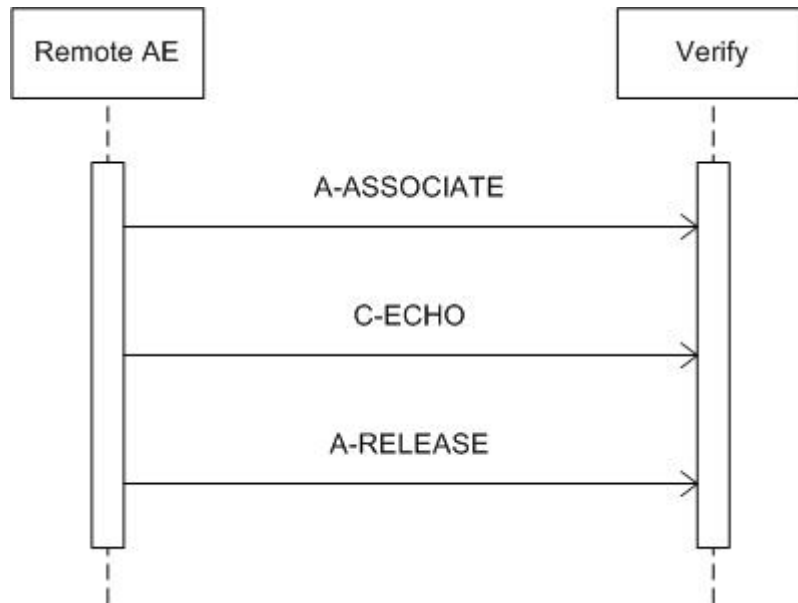

Figure 10: Sequencing of RWA Verify

4.2.1.4.1.2. Accepted Presentation Contexts

The following table gives an overview of the presentation context accepted by the Digital Diagnost AE.

Table 32: Acceptable Presentation Contexts for Verify

Presentation Context Table					
Abstract Syntax		Transfer Syntax		Role	Extended Negotiation
Name	UID	Name List	UID List		
Verification	1.2.840.10008.1.1	ILE	1.2.840.10008.1.2	SCP	None
		ELE	1.2.840.10008.1.2.1	SCP	None
		EBE	1.2.840.10008.1.2.2	SCP	None

The Digital Diagnost AE accepts all contexts in the intersection of the proposed and acceptable Presentation Contexts. This means that multiple Proposed Presentation

Contexts with the same SOP Class but different Transfer Syntaxes are accepted. Nevertheless ELE is the preferred Transfer Syntax. There is no check for duplicate contexts, and these are therefore accepted.

4.2.1.4.1.3. SOP Specific Conformance for SOP Classes

4.2.1.4.1.3.1. Verification SOP Class

Digital Diagnost provides standard conformance to the DICOM Verification Service Class.

Table 33: Digital Diagnost AE C-ECHO Status Processing Behavior

Service Status	Code	Further Meaning	Description
Success	0000	Verification is complete	The Digital Diagnost has successfully received the verification request.

4.2.1.4.2. Store Image

4.2.1.4.2.1. Description and Sequencing of Activities

The Digital Diagnost AE accepts (only from configured systems) associations that are to report asynchronous Storage Commitment events (ref. section 4.2.1.3.3).

4.2.1.4.2.2. Accepted Presentation Contexts

Table 34: Acceptable Presentation Contexts for Store Image

Presentation Context Table					
Abstract Syntax		Transfer Syntax		Role	Extended Negotiation
Name	UID	Name List	UID List		
Storage Commitment Push Model	1.2.840.10008.1.20.1	ILE	1.2.840.10008.1.2	SCU	None
		ELE	1.2.840.10008.1.2.1	SCU	None
		EBE	1.2.840.10008.1.2.2	SCU	None

The Digital Diagnost AE accepts all contexts in the intersection of the proposed and acceptable Presentation Contexts. This means that multiple Proposed Presentation Contexts with the same SOP Class but different Transfer Syntaxes are accepted. Nevertheless ELE is the preferred Transfer Syntax. There is no check for duplicate contexts, and these are therefore accepted.

4.2.1.4.2.3. SOP Specific Conformance for SOP Classes

4.2.1.4.2.3.1. Storage Commitment Push Model SOP Class

The Digital Diagnost AE provides standard conformance to the DICOM Storage Commitment Push Model Class.

On receiving a storage commitment result with Event Type ID 1 (Storage Commitment Request Successful) the Digital Diagnost patient list shall be updated by incrementing the number of committed images and by marking the icon of the related image committed in the Viewing Tool browser.

On receiving a storage commitment result with Event Type ID 2 (Storage Commitment Request Complete – Failures Exist) the Digital Diagnost AE shall behave as summarized in Table 35.

The storage commitment result is entered in the log.

Table 35: Storage Commitment N-EVENT-REPORT Failure Handling Behavior

Failure Reason		Behavior
Code	Semantic	
0110	Processing failure	The user is notified via pop-up. Retry storage commitment request. Log entry.
0112	No such object instance	The user is notified via pop-up. Retry store and storage commitment request. Log entry.
0119	Class / Instance conflict	The user is notified via pop-up. No retry. Log entry.
0122	Referenced SOP class not supported	The user is notified via pop-up. No retry. Log entry.
0131	Duplicate transaction UID	The user is notified via pop-up. No retry. Log entry.
0213	Resource limitation	The user is notified via pop-up. Retry storage commitment request. Log entry.

The status processing behavior of the Digital Diagnost AE is summarized in Table 36.

Table 36: Digital Diagnost AE N-EVENT-REPORT Status Processing Behavior

Service Status	Code	Further Meaning	Description
Success	0000	Successful operation	The Digital Diagnost has successfully received the storage commitment report. Entry in Patient List and Log.

4.3. Network Interfaces

4.3.1. Physical Network Interface

The Digital Diagnost provides DICOM 3.0 TCP/IP Network Communication Support as defined in Part 8 of the DICOM 3.0 Standard.

The Digital Diagnost system supports ISO 8802-3 10BASE-T and 100Base-TX Ethernet.

4.3.2. Additional Protocols

4.3.2.1. NTP

As a configurable option, Digital Diagnost maintains the correct time by synchronizing the time with an NTP Time Server.

4.4. Configuration

The configuration of a Digital Diagnost system is done by means of updating the configuration database. This should be done by Philips service engineers only.

4.4.1. AE Title/Presentation Address Mapping

An important installation issue is the translation from AE title to presentation address. How this is to be performed shall be described in this section.

4.4.1.1. Local AE Titles

The local AE title mapping and configuration is as specified in the following table.

Table 37: AE Title Configuration Table

Application Entity	Default AE Title	Default TCP/IP Port
Digital Diagnost AE	digitalDIAGNOST	3000

4.4.1.2. Remote AE Title/Presentation Address Mapping

All remote applications to be selected as destination (SCP) are configurable for the following items:

- The Application Entity Title of the remote application.
- The Presentation Address of where the remote application should accept association requests.
- A user readable ('logical') name for any single configured AET to facilitate user selection.

4.4.2. Parameters

This section specifies important operational parameters and, if configurable, their default value and range.

Table 38: Configuration Parameters

Parameter	Configurable	Default Value
General Parameters		
Time-out waiting for acceptance or rejection Response to an Association Open Request. (Application Level timeout)	Yes	20 [s]
General DIMSE level time-out values (Verification, Storage, Storage Commitment)	Yes	15 [s]
Time-out waiting for response to TCP/IP connect request. (Low-level timeout)	Yes	20 [s]
Time-out waiting for acceptance of a TCP/IP message over the network. (Low-level timeout)	Yes	20 [s]
Time-out for waiting for data between TCP/IP packets. (Low-level timeout)	Yes	20 [s]
Any changes to default TCP/IP settings, such as configurable stack parameters.	No	-
AE Specific Parameters		
Size constraint in maximum object size	No	-
Maximum PDU size the AE can receive	Yes	28k
Maximum PDU size the AE can send	No	16k for BWLM and MPPS 28k for Verification, Storage and Storage Commitment 64k for Print

Parameter	Configurable	Default Value
AE specific DIMSE level time-out values	No	-
Number of simultaneous Associations by Service and/or SOP Class	No	1
GUI user readable string for remote AE titles	Yes	-
Storage Specific Parameters		
Automatic Transfer (On, Off)	Yes	On
Export Filter ¹	Yes	"none"
Bits Stored attribute value (implies Bits Allocated and High Bit) (8, 10, 12, 15)	Yes	15
Photometric Interpretation attribute value (MONOCHROME1, MONOCHROME2)	Yes	MONOCHROME1
Mode ² (Full Range, Film-like, Grayscale Display Function Standard, Measured)	Yes	Grayscale Display Function Standard
Cxontent of study description attribute (Digital Diagnost internal examination name, value of scheduled procedure step description)	Yes	-
Storage Commitment Specific Parameters		
StCommitNEventTimeout ³	Yes	0 [s]
StCommitRetryCount ⁴	Yes	-1 (unlimited)
StCommitNActionDelay ⁵	Yes	0 [s]
StCommitRetryTimeout ⁶	Yes	30 [s]
Basic Worklist Management Specific Parameters		
BackgroundQuery	Yes	No
BackgrdQueryTimeInterval	Yes	60 [s]
BroadQueryMaxItems (Limit before Cancellation, range 1..1200)	Yes	1000
BroadQueryWithDate (as matching key)	Yes	No
DateRange (Today, Today or earlier, Today or later)	Yes	Today
BroadQueryWithAET (as matching key)	Yes	Yes
AETWildcard ⁷	Yes	No
AETWildcardExpr (wildcard value using '*' and/or '?')	Yes	-
QueryModalityType (CR or DX)	Yes	CR
BroadQueryWithModality (as matching key)	Yes	No
PatientQueryMaxItems (Limit before Cancellation, range 1..1200)	Yes	100
PatientQueryWithDate (as matching key)	Yes	No
PatientQueryWithAET (as matching key)	Yes	Yes
PatientQueryWithModality (as matching key)	Yes	No
PatientQueryWithAccessionNo (optional matching key value)	Yes	Yes
PatientQueryWithName (optional matching key value)	Yes	Yes
PatientNameWithWildcard (optional wildcard value using '*' and/or '?')	Yes	No
PatientQueryWithID (optional matching key value)	Yes	Yes
PatientQueryWithReqProcID (optional matching key value)	Yes	Yes
Print Management Specific Parameters		
Retries	Yes	2
Delay between retries	Yes	60 [s]

-
- Note 1: *The Digital Diagnost system stores images internally with 15-bit depth, MONOCHROME1 format. The pixel values are 10000 times that of the optical density, which these pixels should have on film. The Export Filter converts the Digital Diagnost pixel data into data fitting the requirements of the receiving station.
To meet the different requirements of different receiving stations, it is possible to create one Configuration for every SCP.*
- Note 2: Full Range - *The source data range is mapped to the full destination range.*
- Advantage: Uses the maximum precision of the output range.*
- Disadvantage: There is the possibility that consecutive images are harder to compare.*
- It is possible to apply an additional non-linear pixel transformation.*
- Film-like - *The number of bits is reduced by the division through a constant factor.*
- Advantage: Consecutive images are easier to compare.*
- Disadvantage: Reduced precision, compared to that of full range mode.*
- It is possible to apply an additional non-linear pixel transformation.*
- Grayscale Display Function Standard (p-Values) - *The Digital Diagnost image pixel values represent optical densities on a film according to DICOM PS 3.14. An image is a kind of virtual film, which can be put in front of a virtual light box. The result is a range of luminescence values. These values are transformed into perceptual linear values using the whole output range which is defined by the "Bits stored" parameter. These values are exported. The viewing station should be able to display these values in a perceptual linear manner. This means in most cases a non-linear mapping between the input pixel and the data sent to the graphic card.*
- Advantage: Very good quality, if the viewing station supports the Grayscale Standard Display Function.*
- Disadvantage: There are viewing stations not supporting the Grayscale Standard Display Function.*
- Measured - *In addition to the processing described before, a second pixel transformation is calculated by using measured luminescence values of the viewing device. This results in a perceptual linear behavior of the viewing device.*
- Advantage: It is possible to achieve results similar to the results of a viewing Station supporting the Grayscale Display Function Standard (p-values).*
- Disadvantage: Changing brightness and contrast at the viewing station, the calibration has to be redone and the Export Filter settings must be adapted. Changing window center/window width at the viewing station can produce results below optimum.*
- Note 3: *Enable and set (in seconds) or disable the possibility to accept N-EVENT Reports in the same association the N-ACTION request is sent. Equal to "0": don't accept in the same association Equal to ">0": accept for given seconds (Note: This is an important parameter at installation time that has to be carefully committed with the hospital DICOM-Officer).*
- Note 4: *Set the number of retries if a Storage Commitment request failed. Equal to "-1": retry forever (Note: If the value is set to ">0" the related SOP Instances may get deleted after retry count has expired).*
- Note 5: *Number of seconds to delay a Storage Commitment request. (Note: Use this parameter if the Image Manager is not able to serve a Storage Commitment request immediately after a C-Store.)*
- Note 6: *Set the time (in seconds) between retries of a Storage Commitment request.*
- Note 7: *AET wildcard matching is performed locally, not with DICOM means. In the query C-FIND request the scheduled station AE title is left empty (universal matching).*

5. MEDIA INTERCHANGE

5.1. Implementation Model

The implementation model identifies the DICOM Application Entities and relates them to Real-World Activities.

5.1.1. Application Data Flow Diagram

The Digital Diagnost system consists of one single application entity only: the Digital Diagnost Application Entity (Digital Diagnost AE).

Figure 11 shows the Media Interchange application data flow as a functional overview of the Digital Diagnost AE.

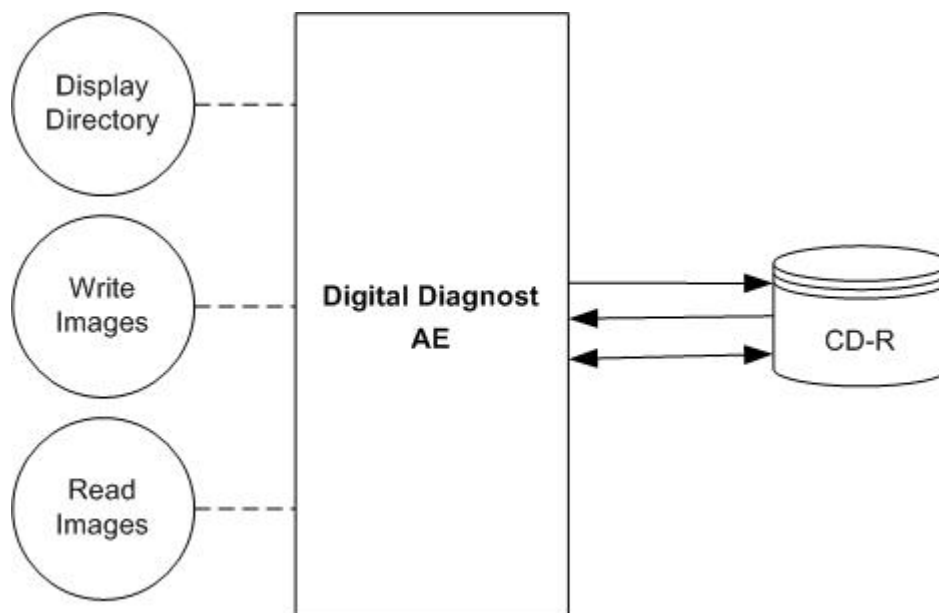

Figure 11: Media Interchange Application Data Flow Diagram

The Digital Diagnost AE will act as a FSR when reading the directory of the medium. The Digital Diagnost AE will act as a FSC/FSU when writing the selected images in a patient folder onto the CD-R medium.

5.1.2. Functional Definitions of AE's

This section shall describe in general terms the functions to be performed by the AE, and the DICOM services used to accomplish these functions.

5.1.2.1. Functional Definition of Digital Diagnost AE

The Digital Diagnost AE is the one and only application entity within the Digital Diagnost. It includes the following service class.

Media Storage Service Class

The Digital Diagnost AE can perform the Media Storage service as SCU, with capabilities for RWA Display Directory (as FSR), RWA Write Images (as FSC/FSU), and RWA Read Images (as FSR).

5.1.3. Sequencing of Real World Activities

The following sequence of Real-World activities is supported by the system.

DICOM Media Usage

Whenever a CD-R has to be written the Digital Diagnost AE first tries to read the DICOMDIR. The Digital Diagnost AE will compile the updated DICOMDIR and any required DICOM images into a CD session image; this CD session image will be written to CD-R.

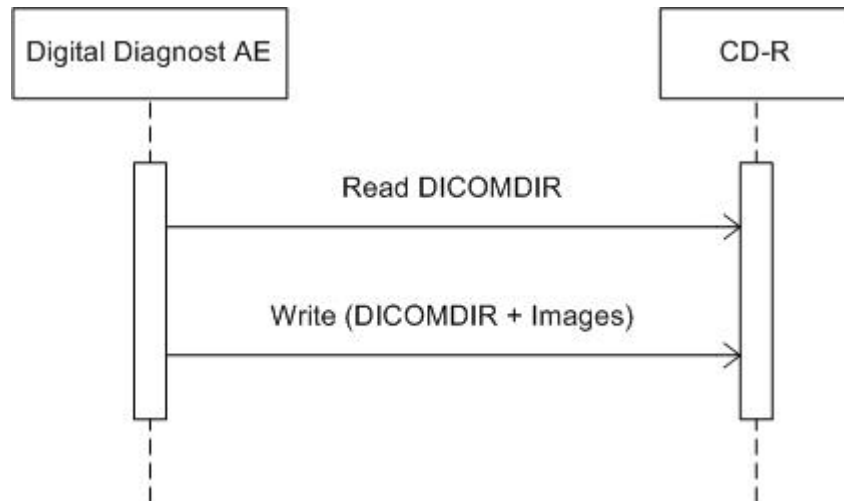

Figure 12: Sequencing of RWA Write Images

The user may optionally store Post, Pre and Stamp images onto CD-R's. This can either be done during the Image Verification (Examination GUI), or in the Viewer GUI.

An overview of patients and images on a CD-R generated by Digital Diagnost can be displayed in the Patient List GUI, and Post, Pre and Stamp images can be retrieved from CD-R in the Viewer GUI.

For viewing the images on Windows systems a copy of the MxLiteView DICOM Viewer is stored on any single CD.

5.1.4. File Meta Information for Implementation Class and Version

This section shall list the values assigned to the File Meta Information attributes (ref. [DICOM] PS 3.10) that pertain to the Implementation Class and Version.

The Implementation Class UID and the Implementation Version Name in the File Meta Header are as specified for Networking (ref. Table 9 in section 4.2.1.2.4).

Table 39: DICOM Implementation Class and Version for Digital Diagnost AE

File Meta Information Version	00, 01
Implementation Class UID	1.3.46.670589.26.1.4
Implementation Version Name	DigiDiagnost1.4

5.2. AE Specifications

The next section contains the specification of the one and only Digital Diagnost Application Entity: Digital Diagnost AE.

5.2.1. Digital Diagnost AE

The Digital Diagnost AE provides Standard Conformance to the DICOM Media Storage Service and File Format ([DICOM] PS 3.10) and the Media Storage Application Profiles STD-GEN-CD ([DICOM] PS 3.11) for reading and writing. Digital Diagnost supports multi-patient and multi-session CD-R disks, both for reading and writing.

The supported Application Profiles, their Roles and the Service Class (SC) options, all defined in DICOM terminology, are listed in Table 40.

Table 40: AE Related Application Profiles, Real-World Activities, and Roles

Supported Application Profile	Real-World Activity	Roles	SC Option
STD-GEN-CD	Display Directory	FSR	Interchange
	Write Images	FSC, FSU	Interchange
	Read Images	FSR	Interchange

Only adding on of instances is supported for the FSU, deleting is not supported.

5.2.1.1. File Meta Information for the Digital Diagnost AE

In the file meta information that pertains to the Application Entity the Source Application Entity Title is set to "DigitalDiagnost".

5.2.1.2. Real-World Activities

This section describes the real-world activities for the roles and Media Storage Service Class options supported by the Digital Diagnost AE as listed in Table 40.

5.2.1.2.1. Display Directory

The Digital Diagnost AE will act as an FSR when reading the directory of the medium. This will result in an overview of the patients, studies, series and images on the Digital Diagnost screen.

5.2.1.2.1.1. Media Storage Application Profile

As depicted in Table 40, the Digital Diagnost AE supports the RWA Display Directory for the STD-GEN-CD Application Profile.

5.2.1.2.1.1.1. Options

The mandatory DICOMDIR keys are required for the correct display of directory information. The display is structured according the DICOM Composite Information Model: Patient, Study, Series, and Image.

5.2.1.2.2. Write Images

When an image transfer to CD-R is initiated then the Digital Diagnost AE acts as an FSC or FSU using the interchange option to export SOP Instances from the local database to a CD-R medium.

5.2.1.2.2.1. Media Storage Application Profile

As depicted in Table 40, the Digital Diagnost AE supports the RWA Write Images for the STD-GEN-CD Application Profile.

5.2.1.2.2.1.1. Options

The DICOMDIR file will be extended when new images are written. In case some attributes are not present in an image but are specified as mandatory in the DICOMDIR definition in DICOM Media, a generated value will be filled in.

Implementation remarks and restrictions

When writing the DICOMDIR records, key values are generated when no value of the corresponding attribute is supplied, according to the following table.

Table 41: Generated Keys

Key	Tag	Generated Value
Patient Keys		
Patient ID	(0010,0020)	At import the Digital Diagnost each time creates a new value based on the Study Instance UID for each new study written to the CD-R (even if this study belongs to a patient recorded earlier). Otherwise the default-generated value shall be a succession of "UNKNOWN", the Patient's Name, the Patient's Birth Date, and the Patient's Sex, concatenated by using underscore characters. If no Patient ID is present in the image, the mandatory patient number of the internal database is used as Patient ID.

5.2.1.2.3. Read Images

When an image transfer from CD-R is initiated then the Digital Diagnost AE acts as an FSR using the interchange option to import SOP Instances from the CD-R medium.

5.2.1.2.3.1. Media Storage Application Profile

As depicted in Table 40, the Digital Diagnost AE supports the RWA Read Images for the STD-GEN-CD Application Profile.

5.2.1.2.3.1.1. Options

The Digital Diagnost only reads CD-R's written by a Digital Diagnost system.

5.3. Augmented and Private Application Profiles

This section shall be used for the description of augmented and private Application Profiles.

5.3.1. Augmented Application Profiles

None.

5.3.2. Private Application Profiles

None.

5.4. Media Configuration

This section specifies important operational parameters and, if configurable, their default value and range.

Table 42: Configuration Parameters

Parameter	Configurable	Default Value
General Parameters		
Source AE Title	No	DigitalDiagnost
Customization Parameters		
Institution Name	Yes	-
Institutional Department Name	Yes	-

6. SUPPORT OF CHARACTER SETS

The Digital Diagnost supports the supplementary character set ISO-IR 100. There are no limitations within the ISO-IR 100 domain.

ISO-IR 100 characters are passed between DICOM services without conversion. In internal log files, characters beyond the 7-bit ASCII set may be displayed using the escape character '\', or in Hex representation.

The use of ISO-IR 100 characters in matching key values is fully supported.

There is no support for character sets beyond the default character repertoire in Network and Media services. Characters of unsupported character sets will be displayed as question marks "?".

7. SECURITY

The Digital Diagnost does not support any specific security measures.

Note that the access to service and configuration dialogues (e.g. setting DICOM parameters) is password protected.

8. ANNEXES

8.1. IOD Contents

8.1.1. Created SOP Instances

This section specifies each IOD created by the Digital Diagnost AE.

Defined abbreviations are:

ALWAYS	the module shall always be present
EMPTY	the (mandatory) module shall not contain any attributes
MAYBE	the module may be present under specified condition
NEVER	the module shall never be present
W	the attribute shall always be present with value
WC	the attribute shall be present with value under specified condition
WO	the attribute shall always be present without value
WOC	the attribute shall be present without value under specified condition
WWO	the attribute shall always be present, either with or without value
WWOC	the attribute shall be present, either with or without value, under specified condition
AUTO	the attribute value is generated automatically
CONF	the attribute value source is a configurable parameter
IMPL	the attribute value source is a user-implicit setting
MPPS	the attribute value source is a modality performed procedure step
MWL	the attribute value source is a modality worklist
SPEC	the attribute value source is a specific DICOM object
USER	the attribute value source is explicit user input

8.1.1.1. Media Storage Directory Storage SOP Class

Table 43: Modules of the Media Storage Directory Storage SOP Class

Information Entity	Module Name	Usage
Media	File-set Identification Module	ALWAYS
	Directory Information Module	ALWAYS

Table 44: Created Media Storage Directory Storage SOP Class Attributes

Name	Tag	VR	Definition	Comment
File-set Identification Module				
File-set ID	0004,1130	CS	W, AUTO	Applied value: 00000000
Specific Character Set of File-set Descriptor File	0004,1142	CS	W, AUTO	Applied value: ISO_IR 100
Directory Information Module				
Offset of the First Directory Record of the Root Directory Entity	0004,1200	UL	W, AUTO	-
Offset of the Last Directory Record of the Root Directory Entity	0004,1202	UL	W, AUTO	
File-set Consistency Flag	0004,1212	US	W, AUTO	
Directory Record Sequence	0004,1220	SQ	W, AUTO	
> Offset of the Next Directory Record	0004,1400	UL	WC, AUTO	-

Name	Tag	VR	Definition	Comment
> Record In-use Flag	0004,1410	US	WC, AUTO	-
> Offset of Referenced Lower-Level Directory Entity	0004,1420	UL	WC, AUTO	-
> Directory Record Type	0004,1430	CS	WC, AUTO	-
> Referenced File ID	0004,1500	CS	WC, AUTO	Format: IMAGES\nnnnnnnn (where n in [0..9])
> Referenced SOP Class UID in File	0004,1510	UI	WC, AUTO	Applied value: 1.2.840 .10008.5.1.4.1.1.1 (Computed Radiography Image Storage)
> Referenced SOP Instance UID in File	0004,1511	UI	WC, AUTO	-
> Referenced Transfer Syntax UID in File	0004,1512	UI	WC, AUTO	Applied value: 1.2.840.10008.1.2.1 (Explicit VR Little Endian)
> Patient Keys				
> Specific Character Set	0008,0005	CS	W, AUTO	Applied value: ISO_IR 100
> Patient's Name	0010,0010	PN	WWO, MWL / USER	Patient's full name.
> Patient ID	0010,0020	LO	W, MWL / USER	Primary hospital identification number or code for the patient.
> Patient's Birth Date	0010,0030	DA	WWO, MWL / USER	Birth date of the patient.
> Patient's Sex	0010,0040	CS	WWO, MWL / USER	Sex of the patient. Applied values: F, M, O
> Study Keys				
> Specific Character Set	0008,0005	CS	W, AUTO	Applied value: ISO_IR 100
> Study Date	0008,0020	DA	W, AUTO	Date the study started.
> Study Time	0008,0030	TM	W, AUTO	Time the study started.
> Accession Number	0008,0050	SH	WWO, MWL / USER	A RIS generated number that identifies the order of the study.
> Study Description	0008,1030	LO	WO, AUTO	-
> Study Instance UID	0020,000D	UI	WC, AUTO	Unique identifier for the study.
> Study ID	0020,0010	SH	W, AUTO	Equipment generated study identifier.
> Series Keys				
> Specific Character Set	0008,0005	CS	W, AUTO	Applied value: ISO_IR 100
> Series Date	0008,0021	DA	W, AUTO	Date the series started.
> Series Time	0008,0031	TM	W, AUTO	Time the series started.
> Modality	0008,0060	CS	W, AUTO	Type of equipment that originally acquired the data used to create the image in this series. Applied value: CR
> Series Description	0008,103E	LO	W, AUTO	User provided description of the series.

Name	Tag	VR	Definition	Comment
> Body Part Examined	0018,0015	CS	W, MWL / IMPL	Specification of the part of the body examined. Applied values: ABDOMEN, ANKLE, ARM, BREAST, CHEST, CLAVICLE, COCCYX, CSPINE, ELBOW, EXTREMITY, FOOT, HAND, HEAD, HEART, HIP, JAW, KNEE, LEG, LSPINE, NECK, PELVIS, SHOULDER, SKULL, SSPINE, TSPINE
> Series Instance UID	0020,000E	UI	W, AUTO	Unique identifier of the series.
> Series Number	0020,0011	IS	W, AUTO	A number that identifies the series.
> Image Keys				
> Specific Character Set	0008,0005	CS	W, AUTO	Applied value: ISO_IR 100
> Image Type	0008,0008	CS	W, AUTO	Image identification characteristics. Applied values: ORIGINAL\PRIMARY, DERIVED\PRIMARY
> SOP Instance UID	0008,0018	UI	W, AUTO	Uniquely identifies the SOP instance.
> Private Creator Group 0019 Block 19	0019,0019	LO	W, AUTO	Applied value: DIDI TO PCR 1.1
> Original Filename	0019,1980	LO	W, AUTO	-
> Instance Number	0020,0013	IS	W, AUTO	Is -1 for pre-images.

8.1.1.2. Storage Commitment Push Model SOP Class

Table 45: Modules of the Storage Commitment Push Model SOP Class

Information Entity	Module Name	Usage
Image	SOP Common Module	EMPTY
	Storage Commitment Module	ALWAYS (N-ACTION)

Table 46: Created Storage Commitment Push Model SOP Class Attributes

Name	Tag	VR	Definition	Comment
Storage Commitment Module				
Transaction UID	(0008,1195)	UI	W, AUTO	-
Referenced SOP Sequence	(0008,1199)	SQ	W, AUTO	-
> Referenced SOP Class UID	(0008,1150)	UI	W, SPEC	-
> Referenced SOP Instance UID	(0008,1155)	UI	W, SPEC	-

8.1.1.3. Modality Performed Procedure Step SOP Class – N-CREATE

Table 47: Modules of the Modality Performed Procedure Step SOP Class – N-CREATE

Information Entity	Module Name	Usage
PPS	SOP Common Module	ALWAYS

Information Entity	Module Name	Usage
	Performed Procedure Step Relationship Module	ALWAYS
	Performed Procedure Step Information Module	ALWAYS
Image Acquisition	Image Acquisition Results Module	ALWAYS
	Radiation Dose Module	ALWAYS
	Billing And Material Management Code Module	ALWAYS

Table 48: Created Modality Performed Procedure Step SOP Class – N-CREATE Attributes

Name	Tag	VR	Definition	Comment
SOP Common Module				
Specific Character Set	0008,0005	CS	W, AUTO	Applied value: ISO_IR 100
SOP Class UID	0008,0016	UI	W, AUTO	Applied value: 1.2.840.10008.3.1.2.3.3
SOP Instance UID	0008,0018	UI	W, AUTO	-
Performed Procedure Step Relationship Module				
Referenced Patient Sequence	0008,1120	SQ	WO, AUTO	-
Patient's Name	0010,0010	PN	WWO, MWL / USER	-
Patient ID	0010,0020	LO	WWO, MWL / USER	-
Issuer of Patient ID	0010,0021	LO	WWO, MWL / USER	Name of authority that issued the Patient ID.
Patient's Birth Date	0010,0030	DA	WWO, MWL / USER	-
Patient's Sex	0010,0040	CS	WWO, MWL / USER	Applied values: F, M, O
Scheduled Step Attribute Sequence	0040,0270	SQ	W, AUTO	-
> Accession Number	0008,0050	SH	WWO, MWL / USER	0 length if unscheduled
> Referenced Study Sequence	0008,1110	SQ	WWO, MWL	No item if unscheduled or if sent without item in BWLM.
>> Referenced SOP Class UID	0008,1150	UI	W, MWL	Value from worklist.
>> Referenced SOP Instance UID	0008,1155	UI	W, MWL	Value from worklist.
> Study Instance UID	0020,000D	UI	W, MWL	-
> Requested Procedure Description	0032,1060	LO	WWO, IMPL / MWL	0 length if unscheduled
> Scheduled Procedure Step Description	0040,0007	LO	WWO, IMPL / MWL	0 length if unscheduled
> Scheduled Protocol Code Sequence	0040,0008	SQ	WO, AUTO	-
> Scheduled Procedure Step ID	0040,0009	SH	WWO, MWL	0 length if unscheduled
> Requested Procedure ID	0040,1001	SH	WWO, MWL	0 length if unscheduled

Name	Tag	VR	Definition	Comment
Performed Procedure Step Information Module				
Procedure Code Sequence	0008,1032	SQ	WWO, IMPL / MWL	Zero length if unscheduled or operator changed the Requested Procedure Code.
> Code Value	0008,0100	SH	W, MWL	Value from worklist.
> Coding Scheme Designator	0008,0102	SH	W, MWL	Value from worklist.
> Coding Scheme Version	0008,0103	SH	WWO, MWL	Value provided by the RIS code table or else zero-length
> Code Meaning	0008,0104	LO	WWO, MWL	Value provided by the RIS code table or else zero-length
Performed Station AE Title	0040,0241	AE	W, CONF	-
Performed Station Name	0040,0242	SH	WO, AUTO	-
Performed Location	0040,0243	SH	WO, AUTO	-
Performed Procedure Step Start Date	0040,0244	DA	W, AUTO	-
Performed Procedure Step Start Time	0040,0245	TM	W, AUTO	-
Performed Procedure Step End Date	0040,0250	DA	WO, AUTO	-
Performed Procedure Step End Time	0040,0251	TM	WO, AUTO	-
Performed Procedure Step Status	0040,0252	CS	W, IMPL	Applied value: IN PROGRESS
Performed Procedure Step ID	0040,0253	SH	W, MWL	-
Performed Procedure Step Description	0040,0254	LO	WWO, IMPL / MWL	By default copied from the Scheduled Procedure Step Description (unless the operator performed different Protocol; in that case the description configured for the actually performed protocol is used). May be zero-length if unscheduled.
Performed Procedure Type Description	0040,0255	LO	WO, AUTO	-
Image Acquisition Results Module				
Modality	0008,0060	CS	W, AUTO	Applied value: CR
Study ID	0020,0010	SH	WWO, AUTO / MWL	If scheduled: Requested Procedure ID; else: equipment generated study identifier.
Performed Protocol Code Sequence	0040,0260	SQ	WWO, IMPL / MWL	Zero length if unscheduled or modified or appended and RIS code table does not provide values.
> Code Value	0008,0100	SH	W, IMPL / MWL	Value from worklist or RIS code table.
> Coding Scheme Designator	0008,0102	SH	W, IMPL / MWL	Value from worklist or RIS code table.
> Coding Scheme Version	0008,0103	SH	WWO, IMPL / MWL	Value from worklist or RIS code table or else zero-length.
> Code Meaning	0008,0104	LO	WWO, IMPL / MWL	Value from worklist or RIS code table or else zero-length.

Name	Tag	VR	Definition	Comment
Performed Series Sequence	0040,0340	SQ	WO, AUTO	-
Radiation Dose Module				
Image Area Dose Product	0018,115E	DS	WO, AUTO	-
Total Number of Exposures	0040,0301	US	WO, AUTO	-
Exposure Dose Sequence	0040,030E	SQ	WO, AUTO	-
Comments on Radiation Dose	0040,0310	ST	WO, AUTO	-
Billing And Material Management Code Module				
Film Consumption Sequence	0040,0321	SQ	WOC, AUTO	Only present if a printer is attached to the system.

8.1.1.4. Modality Performed Procedure Step SOP Class – N-SET

Table 49: Modules of the Modality Performed Procedure Step SOP Class – N-SET

Information Entity	Module Name	Usage
PPS	SOP Common Module	ALWAYS
	Performed Procedure Step Relationship Module	EMPTY
	Performed Procedure Step Information Module	ALWAYS
Image Acquisition	Image Acquisition Results Module	ALWAYS
	Radiation Dose Module	ALWAYS
	Billing And Material Management Code Module	ALWAYS

Table 50: Created Modality Performed Procedure Step SOP Class – N-SET Attributes

Name	Tag	VR	Definition	Comment
SOP Common Module				
SOP Class UID	0008,0016	UI	W, AUTO	Applied value: 1.2.840.10008.3.1.2.3.3
SOP Instance UID	0008,0018	UI	W, AUTO	-
Performed Procedure Step Information Module				
Procedure Code Sequence	0008,1032	SQ	WWO, IMPL / MWL	Zero length if unscheduled or operator changed the Requested Procedure Code.
> Code Value	0008,0100	SH	W, MWL	Value from worklist.
> Coding Scheme Designator	0008,0102	SH	W, MWL	Value from worklist.
> Coding Scheme Version	0008,0103	SH	WWO, MWL	Value provided by the RIS code table or else zero-length
> Code Meaning	0008,0104	LO	WWO, MWL	Value provided by the RIS code table or else zero-length
Performed Procedure Step End Date	0040,0250	DA	W, AUTO	-
Performed Procedure Step End Time	0040,0251	TM	W, AUTO	-
Performed Procedure Step Status	0040,0252	CS	W, IMPL	Applied values: COMPLETED, DISCONTINUED

Name	Tag	VR	Definition	Comment
Performed Procedure Step Description	0040,0254	LO	WWO, IMPL / MWL	By default copied from the Scheduled Procedure Step Description (unless the operator performed different Protocol; in that case the description configured for the actually performed protocol is used). May be zero-length if unscheduled.
Performed Procedure Type Description	0040,0255	LO	WO, AUTO	-
Image Acquisition Results Module				
Performed Protocol Code Sequence	0040,0260	SQ	WWO, IMPL / MWL	Zero length if unscheduled or modified or appended and RIS code table does not provide values.
> Code Value	0008,0100	SH	W, IMPL / MWL	Value from worklist or RIS code table.
> Coding Scheme Designator	0008,0102	SH	W, IMPL / MWL	Value from worklist or RIS code table.
> Coding Scheme Version	0008,0103	SH	WWO, IMPL / MWL	Value from worklist or RIS code table or else zero-length.
> Code Meaning	0008,0104	LO	WWO, IMPL / MWL	Value from worklist or RIS code table or else zero-length.
Performed Series Sequence	0040,0340	SQ	WWO, AUTO	-
> Retrieve AE Title	0008,0054	AE	WO, AUTO	-
> Series Description	0008,103E	LO	WO, AUTO	-
> Performing Physician's Name	0008,1050	PN	WO, AUTO	-
> Operator's Name	0008,1070	PN	WWO, USER	Multi-value; zero length if no name entered or PCR plates were exposed on other system.
> Referenced Image Sequence	0008,1140	SQ	WWO, AUTO	In Non-Tomo/Non-Stitching examinations 1 item only. In Tomo/Stitching examinations n items. Missing after conventional acquisition. No items from repeated exposures.
>> Referenced SOP Class UID	0008,1150	UI	W, AUTO	Applied value: 1.2.840.10008.5.1.4.1.1.1
>> Referenced SOP Instance UID	0008,1155	UI	W, AUTO	-
> Protocol Name	0018,1030	LO	W, AUTO	Name of the examination item that maps the Performed Protocol Code Value.
> Series Instance UID	0020,000E	UI	W, AUTO	-
> Referenced Standalone SOP Instance Sequence	0040,0220	SQ	WO, AUTO	-

Name	Tag	VR	Definition	Comment
Radiation Dose Module				
Image Area Dose Product	0018,115E	DS	WWO, AUTO	Accumulated over all exposures of this MPPS instance. Not including: re-processed images. Includes repeated exposures. Zero length if PCR plates were exposed on other system.
Total Number of Exposures	0040,0301	US	WWO, AUTO	Not counting: reprocessed images. Includes repeated exposures, so may be greater than number of items in Referenced Image Sequence.
Exposure Dose Sequence	0040,030E	SQ	W, AUTO	-
>KVP	0018,0060	DS	WWO, AUTO	No value for PCR plates exposed on other system
>Exposure Time	0018,1150	IS	WWO, AUTO	No value for PCR plates exposed on other system.
>Radiation Mode	0018,115A	CS	W, AUTO	Applied value: PULSED
>X-Ray Tube Current in μ A	0018,8151	DS	WWO, AUTO	No value for PCR plates exposed on other system.
Comments on Radiation Dose	0040,0310	ST	WWO, AUTO	Concatenated string of exposure values. Each exposure is described in one line of format: <index>, <acquisition name>, <int>kV, <float>mAs, <int>ms, SID <int[mm]>, EI <int>, <filter name>, <float>dGycm2, <repeated exposure>, \r\n Note that names and numbers do not contain any commas. Incomplete values if PCR plates exposed on other system.
Billing And Material Management Code Module				
Film Consumption Sequence	0040,0321	SQ	WWOC, AUTO	Only present if a printer is attached to the system and the acquisitions were made on digital medium. Multiple items may be of same type and size.
>Medium Type	2000,0030	CS	WWO, AUTO	Applied value: CLEAR FILM
>Film Size ID	2010,0050	CS	WWO, AUTO	Applied value: 14INX17IN
>Number of Films	2100,0170	IS	WWO, AUTO	-

8.1.1.5. Basic Film Session SOP Class

Table 51: Modules of the Basic Film Session SOP Class

Information Entity	Module Name	Usage
Image	SOP Common Module	EMPTY
Film	Basic Film Session Presentation Module	ALWAYS (N-CREATE)
	Basic Film Session Relationship Module	EMPTY

Table 52: Created Basic Film Session SOP Class Attributes

Name	Tag	VR	Definition	Comment
Basic Film Session Presentation Module				
Number of Copies	2000,0010	IS	W, IMPL	Applied values: 1 to 99
Print Priority	2000,0020	CS	W, AUTO	Applied value: HIGH
Medium Type	2000,0030	CS	W, IMPL	Applied values: BLUE FILM, CLEAR FILM, PAPER
Film Destination	2000,0040	CS	W, AUTO	Applied values: MAGAZINE, PROCESSOR
Film Session Label	2000,0050	LO	W, AUTO	Applied value: Philips Medical Systems

8.1.1.6. Basic Film Box SOP Class

Table 53: Modules of the Basic Film Box SOP Class

Information Entity	Module Name	Usage
Image	SOP Common Module	EMPTY
Film	Basic Film Box Presentation Module	ALWAYS (N-CREATE)
	Basic Film Box Relationship Module	ALWAYS

Table 54: Created Basic Film Box SOP Class Attributes

Name	Tag	VR	Definition	Comment
Basic Film Box Presentation Module				
Image Display Format	(2010,0010)	ST	W, AUTO	Applied values: CUSTOM1, STANDARD1,1
Film Orientation	(2010,0040)	CS	W, IMPL / CONF	Applied values: LANDSCAPE, PORTRAIT
Film Size ID	(2010,0050)	CS	W, IMPL / CONF	Defined terms: A3, A4, 8INX10IN, 8_5INX11IN, 10INX12IN, 10INX14IN, 11INX14IN, 11INX17IN, 14INX14IN, 14INX17IN, 24CMX24CM, 24CMX30CM
Magnification Type	(2010,0060)	CS	W, AUTO	Applied value: NONE
Max Density	(2010,0130)	US	W, AUTO	Applied value: 300
Trim	(2010,0140)	CS	W, AUTO	Applied values: NO, YES
Configuration Information	(2010,0150)	ST	W, AUTO	Contains a vendor specific Lookup-table (LUT); should be applied by the DICOM printer if LUT data is present.

Name	Tag	VR	Definition	Comment
Basic Film Box Relationship Module				
Referenced Film Session Sequence	(2010,0500)	SQ	W, AUTO	Parent film session.
> Referenced SOP Class UID	(0008,1150)	UI	W, AUTO	Applied value: 1.2.840.10008.5.1.1.1 (Basic Film Session)
> Referenced SOP Instance UID	(0008,1155)	UI	W, AUTO	-

8.1.1.7. Basic Grayscale Image Box SOP Class

Table 55: Modules of the Basic Grayscale Image Box SOP Class

Information Entity	Module Name	Usage
Image	SOP Common Module	EMPTY
	Image Box Pixel Presentation Module	ALWAYS (N-SET)

Table 56: Created Basic Grayscale Image Box SOP Class Attributes

Name	Tag	VR	Definition	Comment
Image Box Pixel Presentation Module				
Image Position	(2020,0010)	US	W, AUTO	Applied value: 1
Polarity	(2020,0020)	CS	W, AUTO	Applied value: NORMAL
Basic Grayscale Image Sequence	(2020,0110)	SQ	W, AUTO	-
> Samples per Pixel	(0028,0002)	US	W, AUTO	Applied value: 1
> Photometric Interpretation	(0028,0004)	CS	W, IMPL	Depending on printer medium. Applied values: MONOCHROME1, MONOCHROME2
> Rows	(0028,0010)	US	W, IMPL	Depending on the selected printer type and film size.
> Columns	(0028,0011)	US	W, IMPL	Depending on the selected printer type and film size.
> Bits Allocated	(0028,0100)	US	W, AUTO	Applied values: 8, 16
> Bits Stored	(0028,0101)	US	W, IMPL	Applied values: 8, 12
> High Bit	(0028,0102)	US	W, AUTO	Applied values: 7, 11
> Pixel Representation	(0028,0103)	US	W, AUTO	Applied value: 0
> Pixel Data	(7FE0,0010)	OB OW	W, AUTO	-

8.1.1.8. Printer SOP Class

Table 57: Modules of the Printer SOP Class

Information Entity	Module Name	Usage
Image	SOP Common Module	EMPTY
Printer	Printer Module	EMPTY (N-GET)

Table 58: Created Printer SOP Class Attributes

Name	Tag	VR	Definition	Comment
Printer Module				
-	-	-	-	-

8.1.1.9. Computed Radiography Image Storage SOP Class

Table 59: Modules of the Computed Radiography Image Storage SOP Class

Information Entity	Module Name	Usage
Patient	Patient Module	ALWAYS
	Patient Identification Module	ALWAYS
	Patient Medical Module	ALWAYS
Study	General Study Module	ALWAYS
	Patient Study Module	ALWAYS
Series	General Series Module	ALWAYS
	CR Series Module	ALWAYS
Equipment	General Equipment Module	ALWAYS
Image	General Image Module	ALWAYS
	Image Pixel Module	ALWAYS
	CR Image Module	ALWAYS
	X-Ray Tomography Module	MAYBE, if X-Ray Tomography acquisition
	VOI LUT Module	ALWAYS
	SOP Common Module	ALWAYS
	Private Group	MAYBE (for network) if export of private attributes is enabled

Table 60: Created Computed Radiography Image Storage SOP Class Attributes

Name	Tag	VR	Definition	Comment
Patient Module				
Patient's Name	0010,0010	PN	WWO, MWL / USER	Patient's full name.
Patient ID	0010,0020	LO	WWO, MWL / USER	Primary hospital identification number or code for the patient.
Issuer of Patient ID	0010,0021	LO	WWO, MWL	Name of authority that issued the Patient ID.
Patient's Birth Date	0010,0030	DA	WWO, MWL / USER	Birth data of the patient.
Patient's Sex	0010,0040	CS	WWO, MWL / USER	Sex of the patient. Applied values: F, M, O
Other Patient IDs	0010,1000	LO	WC, MWL	Other identification numbers or codes used to identify the patient. If present value from worklist.
Ethnic Group	0010,2160	SH	WC, MWL	Ethnic group or race of the patient. If present value from worklist.

Name	Tag	VR	Definition	Comment
Patient Comments	0010,4000	LT	WC, MWL	User-defined additional information about the patient. If present value from worklist.
Patient Medical Module				
Medical Alerts	0010,2000	LO	WVO, MWL	Conditions to which medical staff should be alerted (e.g. contagious condition, drug allergies, etc.).
Contrast Allergies	0010,2110	LO	WVO, MWL	Description of prior reaction to contrast agents.
Pregnancy Status	0010,21C0	US	WC, MWL	Describes pregnancy state of patient. If present value from worklist. Applied values: 1 = not pregnant 2 = possibly pregnant 3 = definitely pregnant 4 = unknown
Special Needs	0038,0050	LO	WC, MWL	Medical and social needs (e.g. wheelchair, oxygen, non-English-speaking etc.) If present value from worklist.
Patient State	0038,0500	LO	WC, MWL	Description of patient state (comatose, disoriented, vision impaired etc.) If present value from worklist.
General Study Module				
Study Date	0008,0020	DA	W, AUTO	Date the study started
Study Time	0008,0030	TM	W, AUTO	Time the study started.
Accession Number	0008,0050	SH	WVO, MWL / USER	A RIS generated number that identifies the order of the study.
Referring Physician's Name	0008,0090	PN	WVO, MWL / USER	Patient's referring physician.
Study Description	0008,1030	LO	WC, AUTO / MWL	Configurable to either empty, Examination Name, or Requested Procedure Step Description. If export via network and present value from worklist.
Procedure Code Sequence	0008,1032	SQ	WVO, MWL	A sequence that conveys the (single) type of procedure performed. Only a single Item shall be permitted in this Sequence. Empty for unscheduled procedures.
>Code Value	0008,0100	SH	W, MWL	-
>Coding Scheme Designator	0008,0102	SH	W, MWL	-

Name	Tag	VR	Definition	Comment
>Coding Scheme Version	0008,0103	SH	WC, MWL	Present if the value of the Coding Scheme Designator is not sufficient to identify the Code Value unambiguously.
>Code Meaning	0008,0104	LO	W, MWL	-
Physician(s) of Record	0008,1048	PN	WC, MWL	Name of the physician(s) responsible for overall patient care at the time of study. Value from worklist.
Referenced Study Sequence	0008,1110	SQ	WC, MWL	A sequence providing reference to a Study SOP Class/Instance pair. The sequence may have zero or more items. If present contents from worklist.
>Referenced SOP Class UID	0008,1150	UI	W, MWL	Uniquely identifies the referenced SOP Class. Applied value: 1.2.840.10008.3.1.2.3.1
>Referenced SOP Instance UID	0008,1155	UI	W, MWL	Uniquely identifies the referenced SOP Instance.
Study Instance UID	0020,000D	UI	W, AUTO / MWL	Unique identifier for the Study.
Study ID	0020,0010	SH	WWO, AUTO / MPPS	User or equipment generated Study identifier.
Requesting Service	0032,1033	LO	WC, MWL	Additional attribute, if present value from worklist.
Requested Procedure Description	0032,1060	LO	WC, MWL	Additional attribute, if media storage and present value from worklist.
Patient Study Module				
Additional Patient History	0010,21B0	LT	WC, MWL	Additional information about the patient's medical history.
General Series Module				
Series Date	0008,0021	DA	W, AUTO	Date the Series started.
Series Time	0008,0031	TM	W, AUTO	Time the Series started.
Modality	0008,0060	CS	W, AUTO	Type of equipment that originally acquired the data used to create the image in this series. Applied value: CR
Series Description	0008,103E	LO	W, AUTO	User provided description of the series.
Operator's Name	0008,1070	PN	WC, MPPS / USER	The technologist(s) supporting the series. If entered by user.
Referenced Performed Procedure Step Sequence	0008,1111	SQ	WC, AUTO	Uniquely identifies the Modality Performed Procedure Step SOP Instance to which the series is related. Present if MPPS option is active.

Name	Tag	VR	Definition	Comment
>Referenced SOP Class UID	0008,1150	UI	W, AUTO	Uniquely identifies the referenced SOP Class. Applied value: 1.2.840.10008.3.1.2.3.3
>Referenced SOP Instance UID	0008,1155	UI	W, AUTO	Uniquely identifies the referenced SOP Instance.
Protocol Name	0018,1030	LO	WWO, AUTO / MPPS	Name of the examination item that maps the Performed Protocol Code Value.
Series Instance UID	0020,000E	UI	W, AUTO / MPPS	Unique identifier of the series.
Series Number	0020,0011	IS	W, AUTO	A number that identifies the series.
Laterality	0020,0060	CS	WWO, AUTO	Laterality of (paired) body part examined. Required if the body part examined is a paired structure. Its value can be configured in the examination table. If no value is configured, the corresponding attribute is sent empty. Applied values: L, R
Performed Procedure Step Start Date	0040,0244	DA	W, MPPS	Date on which the Performed Procedure Step started.
Performed Procedure Step Start Time	0040,0245	TM	W, MPPS	Time at which the Performed Procedure Step started.
Performed Procedure Step ID	0040,0253	SH	WC, MPPS	User or equipment generated identifier of that part of a procedure that has been carried out within this step. Present if MPPS option is active.
Performed Procedure Step Description	0040,0254	LO	WWOC, MWL	By default copied from the Scheduled Procedure Step Description (unless the operator performed different protocol; in that case the description configured for the actually performed protocol is used). Present if examination has been scheduled.
Performed Protocol Code Sequence	0040,0260	SQ	WWO, MWL	Sequence describing the protocol performed for this procedure step.
>Code Value	0008,0100	SH	W, MWL	-
>Coding Scheme Designator	0008,0102	SH	W, MWL	-
>Coding Scheme Version	0008,0103	SH	WC, MWL	Present if the value of the Coding Scheme Designator is not sufficient to identify the Code Value unambiguously.
>Code Meaning	0008,0104	LO	W, MWL	-

Name	Tag	VR	Definition	Comment
Request Attributes Sequence	0040,0275	SQ	WWO, MWL	Sequence that contains attributes from the Imaging Service Request.
>Scheduled Procedure Step Description	0040,0007	LO	W, MWL	Institution-generated description or classification of the Scheduled Procedure Step to be performed.
>Scheduled Protocol Code Sequence	0040,0008	SQ	WWO, MWL	If a Procedure Step has not been scheduled by the RIS but entered locally (e.g. as Emergency Case) then this sequence contains an empty item.
>>Code Value	0008,0100	SH	W, MWL	-
>>Coding Scheme Designator	0008,0102	SH	W, MWL	-
>>Coding Scheme Version	0008,0103	SH	WC, MWL	Present if the value of the Coding Scheme Designator is not sufficient to identify the Code Value unambiguously.
>>Code Meaning	0008,0104	LO	W, MWL	-
>Scheduled Procedure Step ID	0040,0009	SH	W, MWL	Identifier for the Scheduled Procedure in the Imaging Service Request.
>Requested Procedure ID	0040,1001	SH	W, MWL	Identifier for the Requested Procedure in the Imaging Service Request.
CR Series Module				
Body Part Examined	0018,0015	CS	W, AUTO	Text description of the part of the body examined. Applied values: ABDOMEN, ANKLE, ARM, BREAST, CHEST, CLAVICLE, COCCYX, CSPINE, ELBOW, EXTREMITY, FOOT, HAND, HEAD, HEART, HIP, JAW, KNEE, LEG, LSPINE, NECK, PELVIS, SHOULDER, SKULL, SSPINE, TSPINE
Filter Type	0018,1160	SH	W, AUTO	Label for the type of filter inserted into the X-ray beam. Applied values: 0.1Cu,1Al, 0.2Cu,1Al, 0mmAl, 2mmAl, Unknown
Collimator/Grid Name	0018,1180	SH	W, AUTO	Label describing any grid inserted.
Focal Spot	0018,1190	DS	W, AUTO	Size of the focal spot in mm. For devices with variable focal spot or multiple focal spots, small dimension followed by large dimension.

Name	Tag	VR	Definition	Comment
Plate Type	0018,1260	SH	W, AUTO	Label of type of storage phosphor plates used in this series.
View Position	0018,5101	CS	W, AUTO	Radiographic view. Applied values: AP, LL, LLD, LLO, PA, RL, RLD, RLO
General Equipment Module				
Manufacturer	0008,0070	LO	W, AUTO	Manufacturer of the equipment that produced the digital images. Applied value: Philips Medical Systems
Institution Name	0008,0080	LO	WWO, CONF	Institution where the equipment is located that produced the digital images.
Station Name	0008,1010	SH	WWO, CONF	User defined name identifying the machine that produced the digital images.
Institutional Department Name	0008,1040	LO	WWO, CONF	Department in the institution where the equipment is located that produced the digital images.
Manufacturer's Model Name	0008,1090	LO	W, AUTO	Manufacturers model number of the equipment that produced the digital images. Applied value: digital DIAGNOST
Device Serial Number	0018,1000	LO	W, AUTO	Manufacturers serial number of the equipment that produced the digital images.
Software Version(s)	0018,1020	LO	W, AUTO	Manufacturers designation of software version of the equipment that produced the digital images. Applied value: Version 1.4
Date of Last Calibration	0018,1200	DA	W, AUTO	Date when the image acquisition device calibration was last changed in any way. Multiple entries may be used for additional calibrations at other times.
Time of Last Calibration	0018,1201	TM	W, AUTO	Time when the image device was last changed in any way. Multiple entries may be used.
General Image Module				
Image Type	0008,0008	CS	W, AUTO	Image identification characteristics. Applied values: DERIVED ORIGINAL, PRIMARY
Content Date	0008,0023	DA	W, AUTO	The date the image pixel data creation started.
Content Time	0008,0033	TM	W, AUTO	The time the image pixel data creation started.

Name	Tag	VR	Definition	Comment
Acquisition Number	0020,0012	IS	WWO, MWL / USER	A number identifying the single continuous gathering of data over a period of time that resulted in this image.
Instance Number	0020,0013	IS	W, AUTO	-1 for unprocessed images; greater for processed images
Patient Orientation	0020,0020	CS	W, AUTO	Required if image does not require Image Orientation and Image Position. Format o1\o2, where o1, o2 are one or two of the defined values: A, P, R, L, H, F
Image Comments	0020,4000	LT	W, AUTO	User-defined comments about the image.
Image Pixel Module				
Samples per Pixel	0028,0002	US	W, AUTO	Number of samples (planes) in this image. Applied value: 1
Rows	0028,0010	US	W, AUTO	Number of rows in the image.
Columns	0028,0011	US	W, AUTO	Number of columns in the image.
Pixel Spacing	0028,0030	DS	WWO, AUTO	Additional physical distance in the patient between the center of each pixel, specified by a numeric pair - adjacent row spacing (delimiter) adjacent column spacing in mm.
Bits Allocated	0028,0100	US	W, AUTO / IMPL	Number of bits allocated for each pixel sample. Each sample shall have the same number of bits allocated. Applied values: 8, 16
Bits Stored	0028,0101	US	W, AUTO / IMPL	Number of bits stored for each pixel sample. Each sample shall have the same number of bits stored. Applied values: 8, 10, 12, 15
High Bit	0028,0102	US	W, AUTO / IMPL	Most significant bit for pixel sample data. Each sample shall have the same high bit. Applied values: 7, 9, 11, 14
Pixel Representation	0028,0103	US	W, AUTO / IMPL	Data representation of the pixel samples. Each sample shall have the same pixel representation. Applied value: 0
Pixel Data	7FE0,0010	OW	W, AUTO	A data stream of the pixel samples that comprises the Image.

Name	Tag	VR	Definition	Comment
CR Image Module				
KVP	0018,0060	DS	W, AUTO / MPPS	Peak kilo voltage output of the X-ray generator used.
Distance Source to Detector	0018,1110	DS	W, AUTO	Distance in mm from the source to detector center; SID: Source Image Distance.
Exposure Time	0018,1150	IS	W, AUTO / MPPS	Time of X-ray exposure in msec.
Exposure	0018,1152	IS	W, AUTO	The product of exposure time and X-ray Tube Current expressed in mAs.
Image Area Dose Product	0018,115E	DS	W, AUTO / MPPS	X-Ray dose, measured in dGy*cm*cm, to which the patient was exposed for the acquisition of this image.
Imager Pixel Spacing	0018,1164	DS	W, AUTO	Physical distance measured at the front plane of the Image Receptor housing between the center of each pixel. Specified by a numeric pair - row spacing value (delimiter) column spacing value - in mm. In the case of CR, the front plane is defined to be the external surface of the CR plate closest to the patient and radiation source.
Grid	0018,1166	CS	W, AUTO	Identify the grid. Only a single value shall be present. Applied values: IN = A Grid is positioned NONE = No Grid is used
Generator Power	0018,1170	IS	W, AUTO	Power in kW to the X-ray generator.
Acquisition Device Processing Description	0018,1400	LO	WC, AUTO	Describes device-specific processing associated with the image (e.g. Organ Description). If Instance Number >= 0.
Processing Function	0018,5020	LO	W, AUTO	Note: This attribute has been added for Thoravision (declared as "extended CR-Image attribute") and has been used since.
Postprocessing Function	0018,5021	LO	W, AUTO	Note: This attribute has been added for Thoravision (declared as "extended CR-Image attribute") and has been used since.
Sensitivity	0018,6000	DS	WC, AUTO	Read out sensitivity. If Instance Number >= 0.

Name	Tag	VR	Definition	Comment
Photometric Interpretation	0028,0004	CS	W, AUTO / IMPL	Specifies the intended interpretation of the pixel data. Applied values: MONOCHROME1, MONOCHROME2
X-Ray Tomography Module				
Scan Options	0018,0022	CS	W, AUTO	Additional parameters of scanning sequence. Applied value: TOMO
Tomo Layer Height	0018,1460	DS	W, AUTO	Distance in mm between the table surface and the sharp image plane.
Tomo Angle	0018,1470	DS	W, AUTO	Angle span in degrees of rotation of X-ray Source during X-ray acquisition.
Tomo Time	0018,1480	DS	W, AUTO	Time in seconds the source has taken to rotate the Tomo Angle during X-ray acquisition.
VOI LUT Module				
Window Center	0028,1050	DS	W, AUTO	Defines the window center for display.
Window Width	0028,1051	DS	W, AUTO	Defines the window width for display.
SOP Common Module				
Specific Character Set	0008,0005	CS	W, AUTO	Applied value: ISO_IR 100
SOP Class UID	0008,0016	UI	W, AUTO / MPPS	Uniquely identifies the SOP Class. Applied value: 1.2.840.10008.5.1.4.1.1.1 (Computed Radiography Image Storage)
SOP Instance UID	0008,0018	UI	W, AUTO / MPPS	Uniquely identifies the SOP Instance.
Private Group				
Private Creator Group 0019 Block 12	0019,0012	LO	WC, AUTO	If media storage. Applied Value: SPI-P-Private-DiDi Release 1
Private Creator Group 0019 Block 19	0019,0019	LO	W, AUTO	Applied Value: DIDI TO PCR 1.1
Post Mode String	0019,1200	LT	WC, AUTO	If media storage and Instance Number >= 1.
Post Data	0019,1201	LT	WC, AUTO	If media storage and Instance Number >= 1.
Image Header	0019,1210	LT	WC, AUTO	If media storage.
Route AET	0019,1922	LO	WWOC, AUTO	Present if image is sent to EasyVision for being printed.
PCR Print Scale	0019,1923	DS	W, AUTO	-
PCR Print Job End	0019,1924	ST	WWOC, AUTO	Present if image is sent to EasyVision for being printed.
PCR No Film Copies	0019,1925	IS	W, AUTO	-
PCR Film Layout Position	0019,1926	IS	W, AUTO	-
PCR Print Report Name	0019,1927	ST	WWOC, AUTO	Present if image is sent to EasyVision for being printed.

Name	Tag	VR	Definition	Comment
RAD Protocol Printer	0019,1970	ST	WWOC, AUTO	Present if image is sent to EasyVision for being printed.
RAD Protocol Medium	0019,1971	ST	WWOC, AUTO	Present if image is sent to EasyVision for being printed.
Exposure Index	0019,1989	IS	WC, AUTO	If media storage.
Collimator X	0019,198A	IS	WC, AUTO	If media storage.
Collimator Y	0019,198B	IS	WC, AUTO	If media storage.
Print Marker	0019,198C	LO	WC, AUTO	If media storage.
RGDV Name	0019,198D	LO	WC, AUTO	If media storage.
Acqd Sensitivity	0019,198E	LO	WC, AUTO	If media storage.
Processing Category	0019,198F	LO	WC, AUTO	If media storage and image is unprocessed (Instance Number = -1).
Unprocessed Flag	0019,1990	LO	W, AUTO	Applied values: no, yes
Key Values	0019,1991	DS	WC, AUTO	Required if Unprocessed Flag = yes.
Destination Postprocessing Function	0019,1992	LO	WC, AUTO	Required if Unprocessed Flag = yes.
Version	0019,19A0	LO	WC, AUTO	Required if image was created with 'Unique' option switched on and Unprocessed Flag = yes. Applied value: 0.2
Ranging Mode	0019,19A1	LO	WC, AUTO	Required if Unprocessed Flag = yes and Version = '0.2'. Applied Values: AUTO2, FIXED, MANUAL, READER, SEMI
Abdomen Brightness	0019,19A2	DS	WC, AUTO	Required if Unprocessed Flag = yes and Version = '0.2'.
Fixed Brightness	0019,19A3	DS	WC, AUTO	Required if Unprocessed Flag = yes and Version = '0.2'.
Detail Contrast	0019,19A4	DS	WC, AUTO	Required if Unprocessed Flag = yes and Version = '0.2'.
Contrast Balance	0019,19A5	DA	WC, AUTO	Required if Unprocessed Flag = yes and Version = '0.2'.
Structure Boost	0019,19A6	DS	WC, AUTO	Required if Unprocessed Flag = yes and Version = '0.2'.
Structure Preference	0019,19A7	DS	WC, AUTO	Required if Unprocessed Flag = yes and Version = '0.2'.
Noise Robustness	0019,19A8	DS	WC, AUTO	Required if Unprocessed Flag = yes and Version = '0.2'.
Noise Dose Limit	0019,19A9	DS	WC, AUTO	Required if Unprocessed Flag = yes and Version = '0.2'.

Name	Tag	VR	Definition	Comment
Noise Dose Step	0019,19AA	DS	WC, AUTO	Required if Unprocessed Flag = yes and Version = '0.2'.
Noise Frequency Limit	0019,19AB	DS	WC, AUTO	Required if Unprocessed Flag = yes and Version = '0.2'.
Weak Contrast Limit	0019,19AC	DS	WC, AUTO	Required if Unprocessed Flag = yes and Version = '0.2'.
Strong Contrast Limit	0019,19AD	DS	WC, AUTO	Required if Unprocessed Flag = yes and Version = '0.2'.
Structure Boost Offset	0019,19AE	DS	WC, AUTO	Required if Unprocessed Flag = yes and Version = '0.2'.
Smooth Gain	0019,19AF	LO	WC, AUTO	Required if Unprocessed Flag = yes and Version = '0.2'. Applied Values: NO, YES
Measure Field 1	0019,19B0	LO	WC, AUTO	Required if Unprocessed Flag = yes and Version = '0.2'. Applied Values: FULLFIELD, HALFFIELD, QUARTERFIELD, SPLITFIELD
Measure Field 2	0019,19B1	LO	WC, AUTO	Required if Unprocessed Flag = yes and Version = '0.2'. Applied Values: FULLFIELD, HALFFIELD, QUARTERFIELD, SPLITFIELD
Key Percentile 1	0019,19B2	IS	WC, AUTO	Required if Unprocessed Flag = yes and Version = '0.2'.
Key Percentile 2	0019,19B3	IS	WC, AUTO	Required if Unprocessed Flag = yes and Version = '0.2'.
Density LUT	0019,19B4	IS	WC, AUTO	Required if Unprocessed Flag = yes and Version = '0.2'. Applied Values: 0, 1, 2, 3, 4
Brightness	0019,19B5	DS	WC, AUTO	Required if Unprocessed Flag = yes.
Gamma	0019,19B6	DS	WC, AUTO	Required if Unprocessed Flag = yes.
Private Creator Group 0089 Block 10	0089,0010	LO	W, AUTO	Applied Value: DIDI TO PCR 1.1
Stamp Image Sequence	0089,1010	SQ	W, AUTO	-
>Samples per Pixel	0028,0002	US	W, AUTO	Applied Value: 1
>Photometric Interpretation	0028,0004	CS	W, AUTO	Applied Value: MONOCHROME1
>Rows	0028,0010	US	W, AUTO	-
>Columns	0028,0011	US	W, AUTO	-
>Bits Allocated	0028,0100	US	W, AUTO	Applied Value: 8
>Bits Stored	0028,0101	US	W, AUTO	Applied Value: 8
>High Bit	0028,0102	US	W, AUTO	Applied Value: 7

Name	Tag	VR	Definition	Comment
>Pixel Representation	0028,0103	US	W, AUTO	Applied Value: 0000
>Pixel Data	7FE0,0010	OW	W, AUTO	-

8.1.1.10. Modality Worklist Information Model – FIND SOP Class

Table 61: Modules of the Modality Worklist Information Model – FIND SOP Class

Information Entity	Module Name	Usage
General	SOP Common Module	ALWAYS
Study	Scheduled Procedure Step Module	ALWAYS
	Requested Procedure Module	ALWAYS
	Imaging Service Request Module	ALWAYS
Visit	Visit Identification Module	ALWAYS
	Visit Status Module	ALWAYS
	Visit Relationship Module	EMPTY
	Visit Admission Module	NEVER
Patient	Patient Relationship Module	NEVER
	Patient Identification Module	ALWAYS
	Patient Demographic Module	ALWAYS
	Patient Medical Module	ALWAYS

Table 62: Created Modality Worklist Information Model – FIND SOP Class Attributes

Name	Tag	VR	Definition	Comment
SOP Common Module				
Specific Character Set	0008,0005	CS	WC, IMPL	Applied Value: ISO_IR 100
Scheduled Procedure Step Module				
Scheduled Procedure Step Sequence	0040,0100	SQ	W, AUTO	-
> Modality	0008,0060	CS	WWO, AUTO / USER	Optional matching key; evaluation requires optional GUI configuration. Applied Value(s): CR, DX
> Requested Contrast Agent	0032,1070	LO	WO, AUTO	Evaluation requires optional GUI configuration.
> Scheduled Station AE Title	0040,0001	AE	WWO, AUTO / USER	Optional matching key; the return attribute may contain more than 1 value if local wildcard matching is configured.
> Scheduled Procedure Step Start Date	0040,0002	DA	WWO, AUTO / USER	Optional matching key.
> Scheduled Procedure Step Start Time	0040,0003	TM	WO, AUTO	-
> Scheduled Procedure Step End Date	0040,0004	DA	WO, AUTO	Not evaluated.
> Scheduled Procedure Step End Time	0040,0005	TM	WO, AUTO	Not evaluated.
> Scheduled Performing Physician's Name	0040,0006	PN	WO, AUTO	Evaluation requires optional GUI configuration.
> Scheduled Procedure Step Description	0040,0007	LO	WO, AUTO	-

Name	Tag	VR	Definition	Comment
> Scheduled Protocol Code Sequence	0040,0008	SQ	WO, AUTO	-
>> Code Value	0008,0100	SH	WO, AUTO	-
>> Coding Scheme Designator	0008,0102	SH	WO, AUTO	Not evaluated.
>> Coding Scheme Version	0008,0103	SH	WO, AUTO	Not evaluated.
>> Code Meaning	0008,0104	LO	WO, AUTO	Not evaluated.
> Scheduled Procedure Step ID	0040,0009	SH	WO, AUTO	-
> Scheduled Station Name	0040,0010	SH	WO, AUTO	Evaluation requires optional GUI configuration.
> Scheduled Procedure Step Location	0040,0011	SH	WO, AUTO	Evaluation requires optional GUI configuration.
> Pre-Medication	0040,0012	LO	WO, AUTO	Evaluation requires optional GUI configuration.
> Scheduled Procedure Step Status	0040,0020	CS	WO, AUTO	Evaluation requires optional GUI configuration.
> Comments on the Scheduled Procedure Step	0040,0400	LT	WO, AUTO	Truncated to 256 char; \n and \r replaced by ' '; Leading & trailing white-space ignored; Evaluation requires optional GUI configuration.
Requested Procedure Module				
Referenced Study Sequence	0008,1110	SQ	WO, AUTO	-
> Referenced SOP Class UID	0008,1150	UI	WO, AUTO	-
> Referenced SOP Instance UID	0008,1155	UI	WO, AUTO	-
Study Instance UID	0020,000D	UI	WO, AUTO	-
Requested Procedure Description	0032,1060	LO	WO, AUTO	-
Requested Procedure Code Sequence	0032,1064	SQ	WO, AUTO	-
> Code Value	0008,0100	SH	WO, AUTO	-
> Coding Scheme Designator	0008,0102	SH	WO, AUTO	Not evaluated.
> Coding Scheme Version	0008,0103	SH	WO, AUTO	Not evaluated.
> Code Meaning	0008,0104	LO	WO, AUTO	Not evaluated.
Requested Procedure ID	0040,1001	SH	WWO, AUTO / USER	Optional matching key for patient query.
Requested Procedure Priority	0040,1003	SH	WO, AUTO	Evaluation requires optional GUI configuration.
Patient Transport Arrangements	0040,1004	LO	WO, AUTO	Evaluation requires optional GUI configuration.

Name	Tag	VR	Definition	Comment
Names of Intended Recipients of Results	0040,1010	PN	WO, AUTO	Not evaluated.
Requested Procedure Comments	0040,1400	LT	WO, AUTO	Truncated to 256 char; \n and \r replaced by ' '; Leading & trailing white-space ignored; Evaluation requires optional GUI configuration.
Imaging Service Request Module				
Accession Number	0008,0050	SH	WVO, AUTO / USER	Optional matching key for patient query.
Referring Physician's Name	0008,0090	PN	WO, AUTO	-
Requesting Physician	0032,1032	PN	WO, AUTO	Evaluation requires optional GUI configuration.
Requesting Service	0032,1033	LO	WO, AUTO	Evaluation requires optional GUI configuration.
Imaging Service Request Comments	0040,2400	LT	WO, AUTO	Not evaluated.
Visit Identification Module				
Admission ID	0038,0010	LO	WO, AUTO	Evaluation requires optional GUI configuration.
Visit Status Module				
Current Patient Location	0038,0300	LO	WO, AUTO	-
Patient Identification Module				
Patient's Name	0010,0010	PN	WVO, AUTO / USER	Optional matching key for patient query.
Patient ID	0010,0020	LO	WVO, AUTO / USER	Optional matching key for patient query.
Issuer of Patient ID	0010,0021	LO	WO, AUTO	-
Other Patient IDs	0010,1000	LO	WO, AUTO	Evaluation requires optional GUI configuration.
Patient Demographic Module				
Patient's Birth Date	0010,0030	DA	WO, AUTO	-
Patient's Sex	0010,0040	CS	WO, AUTO	Defined values: F, M, O
Patient's Weight	0010,1030	DS	WO, AUTO	Evaluation requires optional GUI configuration.
Ethnic Group	0010,2160	SH	WO, AUTO	-
Patient Comments	0010,4000	LT	WO, AUTO	Truncated to 256 char; \n and \r replaced by ' '; Leading & trailing white-space ignored.
Patient Data Confidentiality Constraint Description	0040,3001	LO	WO, AUTO	-
Patient Medical Module				
Medical Alerts	0010,2000	LO	WO, AUTO	-

Name	Tag	VR	Definition	Comment
Contrast Allergies	0010,2110	LO	WO, AUTO	-
Additional Patient History	0010,21B0	LT	WO, AUTO	Truncated to 256 char; \n and \r replaced by ' '; Leading & trailing white- space ignored.
Pregnancy Status	0010,21C0	US	WO, AUTO	-
Special Needs	0038,0050	LO	WO, AUTO	-
Patient State	0038,0500	LO	WO, AUTO	-

8.1.2. Usage of Attributes from Received IOD's

The Digital Diagnost AE does not receive SOP instances. The usage of attributes received via Modality Worklist is described in section 4.2.1.3.2.

8.1.3. Attribute Mapping

The following table shows the relation between BWLM and MPPS and image storage attributes.

Table 63: Attribute Mapping during Modality Workflow

Name	BWLM Tag	MPPS		Image IOD Tag
		Create Tag	Set Tag	
Accession Number	0008,0050	0008,0050	-	0008,0050
Modality	-	0008,0060	-	0008,0060
Referring Physician's Name	0008,0090	-	-	0008,0090
Operators' Name	-	-	0008,1070	0008,1070
Referenced Study Sequence	0008,1110	0008,1110	-	0008,1110
Referenced Image Sequence	-	-	(0008,1140)	-
> Referenced SOP Class UID	-	-	0008,1150	0008,0016
SOP Class UID	-	-	-	-
> Referenced SOP Instance UID	-	-	0008,1155	0008,0018
SOP Instance UID	-	-	-	-
Patient's Name	0010,0010	0010,0010	-	0010,0010
Patient ID	0010,0020	0010,0020	-	0010,0020
Issuer of Patient ID	0010,0021	0010,0021	-	0010,0021
Patient's Birth Date	0010,0030	0010,0030	-	0010,0030
Patient's Sex	0010,0040	0010,0040	-	0010,0040
Other Patient IDs	0010,1000	0010,1000	-	0010,1000
Medical Alerts	0010,2000	-	-	0010,2000
Contrast Allergies	0010,2110	-	-	0010,2110
Ethnic group	0010,2160	-	-	0010,2160
Additional Patient History	0010,21B0	-	-	0010,21B0
Pregnancy Status	0010,21C0	-	-	0010,21C0
Patient Comments	0010,4000	-	-	0010,4000
KVp	-	-	0018,0060	0018,0060
Protocol Name	-	-	0018,1030	0018,1030
Exposure Time	-	-	0018,1150	0018,1150
Image Area Dose Product	-	-	(0018,115E) ¹	(0018,115E) ²
Study Instance UID	0020,000D	0020,000D	-	0020,000D
Series Instance UID	-	-	0020,000E	0020,000E
Study ID	-	0020,0010	-	0020,0010
Requesting Service	0032,1033	-	-	0032,1033

Name	BWLM Tag	MPPS		Image IOD Tag
		Create Tag	Set Tag	
Requested Procedure Description	0032,1060	0032,1060	-	-
Requested Procedure Code Sequence ³	0032,1064	0008,1032	0008,1032	0008,1032
Performed Procedure Code Sequence				
Special Needs	0038,0050	-	-	0038,0050
Patient State	0038,0500	-	-	0038,0500
Scheduled Procedure Step Description ⁴	0040,0007	0040,0007	-	0040,0007
Performed Procedure Step Description		0040,0254	-	0040,0254
Scheduled Protocol Code Sequence ⁴	0040,0008	0040,0260	0040,0260	0040,0008
Performed Protocol Code Sequence				0040,0260
Scheduled Procedure Step ID	0040,0009	0040,0009	-	0040,0009
Performed Procedure Step Start Date	-	0040,0244	-	0040,0244
Performed Procedure Step Start Time	-	0040,0245	-	0040,0245
Performed Procedure Step ID	-	0040,0253	-	0040,0253
Requested Procedure ID	0040,1001	0040,1001	-	0040,1001

Note 1: Value accumulated from all acquisitions performed in this step, including dropped (repeated) acquisitions.

Note 2: Image related specific value.

Note 3: If procedure is performed as requested.

Note 4: If protocol is performed as scheduled.

8.1.4. Coerced/Modified fields

The user may change the attribute values of the following attributes.

Table 64: Coerced/Modified Attributes

Name	Tag	Comment
Patient Module		
Patient's Name	0010,0010	Patient's full name.
Patient ID	0010,0020	Primary hospital identification number or code for the patient.
Patient's Birth Date	0010,0030	Birth data of the patient.
Patient's Sex	0010,0040	Sex of the patient. Applied values: F, M, O
General Study Module		
Accession Number	0008,0050	A RIS generated number that identifies the order of the study.

Optionally the user may modify other patient attribute values of attributes that have been configured accessible in the Patient Data Entry GUI.

The user may also modify the scheduled acquisition protocol according to actual conditions or medical advice. In this case the Scheduled Protocol Code will differ from the Performed Protocol Code.

Note that default names and Patient ID domains for emergency patients are configurable.

8.2. Data Dictionary of Private Attributes

The Digital Diagnost may use the following private attributes.

Table 65: Private Attributes

Name	Tag	VR	VM	Comment
Private Creator Group 0019 Block 12	0019,0012	LO	1	Private creator data element.

Name	Tag	VR	VM	Comment
Private Creator Group 0019 Block 19	0019,0019	LO	1	Private creator data element.
Post Mode String	0019,1200	LT	1	-
Post Data	0019,1201	LT	1	-
Image Header	0019,1210	LT	1	-
Route AET	0019,1922	LO	1	-
PCR Print Scale	0019,1923	DS	1	-
PCR Print Job End	0019,1924	ST	1	-
PCR No Film Copies	0019,1925	IS	1	-
PCR Film Layout Position	0019,1926	IS	1	-
PCR Print Report Name	0019,1927	ST	1	-
RAD Protocol Printer	0019,1970	ST	1	-
RAD Protocol Medium	0019,1971	ST	1	-
Original Filename	0019,1980	LO	1	-
Exposure Index	0019,1989	IS	1	-
Collimator X	0019,198A	IS	1	-
Collimator Y	0019,198B	IS	1	-
Print Marker	0019,198C	LO	1	-
RGDV Name	0019,198D	LO	1	-
Acqd Sensitivity	0019,198E	LO	1	-
Processing Category	0019,198F	LO	1	-
Unprocessed Flag	0019,1990	LO	1	-
Key Values	0019,1991	DS	2	-
Destination Postprocessing Function	0019,1992	LO	1	-
Version	0019,19A0	LO	1	-
Ranging Mode	0019,19A1	LO	1	-
Abdomen Brightness	0019,19A2	DS	1	-
Fixed Brightness	0019,19A3	DS	1	-
Detail Contrast	0019,19A4	DS	1	-
Contrast Balance	0019,19A5	DA	1	-
Structure Boost	0019,19A6	DS	1	-
Structure Preference	0019,19A7	DS	1	-
Noise Robustness	0019,19A8	DS	1	-
Noise Dose Limit	0019,19A9	DS	1	-
Noise Dose Step	0019,19AA	DS	1	-
Noise Frequency Limit	0019,19AB	DS	1	-
Weak Contrast Limit	0019,19AC	DS	1	-
Strong Contrast Limit	0019,19AD	DS	1	-
Structure Boost Offset	0019,19AE	DS	1	-
Smooth Gain	0019,19AF	LO	1	-
Measure Field 1	0019,19B0	LO	1	-
Measure Field 2	0019,19B1	LO	1	-
Key Percentile 1	0019,19B2	IS	1	-
Key Percentile 2	0019,19B3	IS	1	-
Density LUT	0019,19B4	IS	1	-
Brightness	0019,19B5	DS	1	-
Gamma	0019,19B6	DS	1	-
Private Creator Group 0089 Block 10	0089,0010	LO	1	Private creator data element.
Stamp Image Sequence	0089,1010	SQ	1	-
>Samples per Pixel	0028,0002	US	1	Number of samples (planes) in this image.
>Photometric Interpretation	0028,0004	CS	1	Specifies the intended interpretation of the pixel data.
>Rows	0028,0010	US	1	Number of rows in the image.
>Columns	0028,0011	US	1	Number of columns in the image.

Name	Tag	VR	VM	Comment
>Bits Allocated	0028,0100	US	1	Number of bits allocated for each pixel sample.
>Bits Stored	0028,0101	US	1	Number of bits stored for each pixel sample.
>High Bit	0028,0102	US	1	Most significant bit for pixel sample data.
>Pixel Representation	0028,0103	US	1	Data representation of the pixel samples.
>Pixel Data	7FE0,0010	OW	1	A data stream of pixel samples that comprise the image.

8.3. Coded Terminology and Templates

The Digital Diagnost provides tables for configuring the codes for the Modality Assisted Acquisition Protocol Setting capability. These tables allow for mapping of examination types on RIS scheduled codes. No defaults are provided.

If these tables are not configured, the user must select the appropriate Examination items from an anatomic menu manually.

Table 66: Examination Code Mapping

Requested Procedure Description	Requested Procedure Code Item	Scheduled Procedure Step Description	Scheduled Protocol Code Item	Corresponding Digital Diagnost Examination Item
RIS defined value for 0032,1060	Item of 0032,1064 with RIS defined values for: 0008,0100 0008,0102 0008,0103 0008,0104	0040,0007	Item of 0040,0008 with RIS defined values for: 0008,0100 0008,0102 0008,0103 0008,0104	e.g. 'Thorax', with default acquisition settings for positions PA and LAT, and optional positions.

8.4. Grayscale Image consistency

The Digital Diagnost image pixel values represent optical densities on a film according to PS 3.14-XXXX. An image is a kind of virtual film, that can be put in front of a virtual light box. The result is a range of luminescence values. These values are transformed into perceptual linear values using the whole output range as defined by the "Bits stored" parameter. These values are exported.

8.5. Standard Extended/Specialized/Private SOPs

No specialized or private SOP classes are supported.

8.5.1. Computed Radiography Image Storage SOP Class

The Computed Radiography Image Storage SOP class is extended to create a standard extended SOP class by addition of standard and private attributes to the created SOP Instances as documented in section 8.1.1.9.

8.6. Private Transfer Syntaxes

None.