



(Passport Header)



<b>PHILIPS HEALTHCARE</b>	<b>Product Recycling Passport</b>	Page 1 of 5
-------------------------------	-----------------------------------	-------------

<b>Product name:</b>	<b>MicroDose SI</b>		
<b>Identification code(s)</b>	Model Water 400V L50 WE – 4512 2010 9531 Model Water Std voltage L50 WG – 4512 2010 9541		
<b>Total weight (in Kg)</b>	<b>660</b>		
<b>Producer/ Manufacturer</b>	<b>Name company:</b>	<b>Philips Digital Mammography Sweden AB</b>	
	<b>Address:</b>	<b>Smidesvägen 5</b>	
	<b>Zip code:</b>	<b>SE-171 41 Solna</b>	
	<b>Country:</b>	<b>Sweden</b>	

<b>Recycle Info</b>	<b>Items:</b>	<b>Location</b>
<b>General Hazards (Desinfection)</b>	For dismantling activities Treatment Facilities must consider the national requirements. For personnel which can come into contact with contaminated material, preventive measures pursuant to national requirements must be taken into account.	
  <b>Fluids / Gases</b>	Oil, remove before dismantling	Figure 1 (6) and figure 2 (1)
	Cooling fluid tank. Remove before dismantling. Waste must be disposed of in accordance with, state and local environmental control regulations.	Figure 1 (7) and figure 2 (2)
  <b>Special attention</b>	Heavy moving parts, dismantle horizontally	Figure 1 (1)

(Passport Header)

<b>PHILIPS HEALTHCARE</b>	<b>Product Recycling Passport</b>	Page 2 of 5
-------------------------------	-----------------------------------	-------------

	Type:	Location
<p><b>Batteries</b></p>  <p><b>To be Removed</b></p>	CR button battery (Lithium metal) 1x, in computer	Figure 1 (2)
	LR6 AA battery	Figure 3 (1)
	Substances:	Location
<p><b>Hazardous</b></p>  <p><b>To be Removed</b></p>	Beryllium (Be) in X-ray tube	Figure 1 (3)
	Lead(Pb)	Figure 1 (4)
	Mercury (Hg), LCD panel	Figure 1 (5)

Show locations of materials mentioned on the previous sheet. (Picture information)

(Passport Header)

PHILIPS HEALTHCARE	<b>Product Recycling Passport</b>	Page 3 of 5
-----------------------	-----------------------------------	-------------

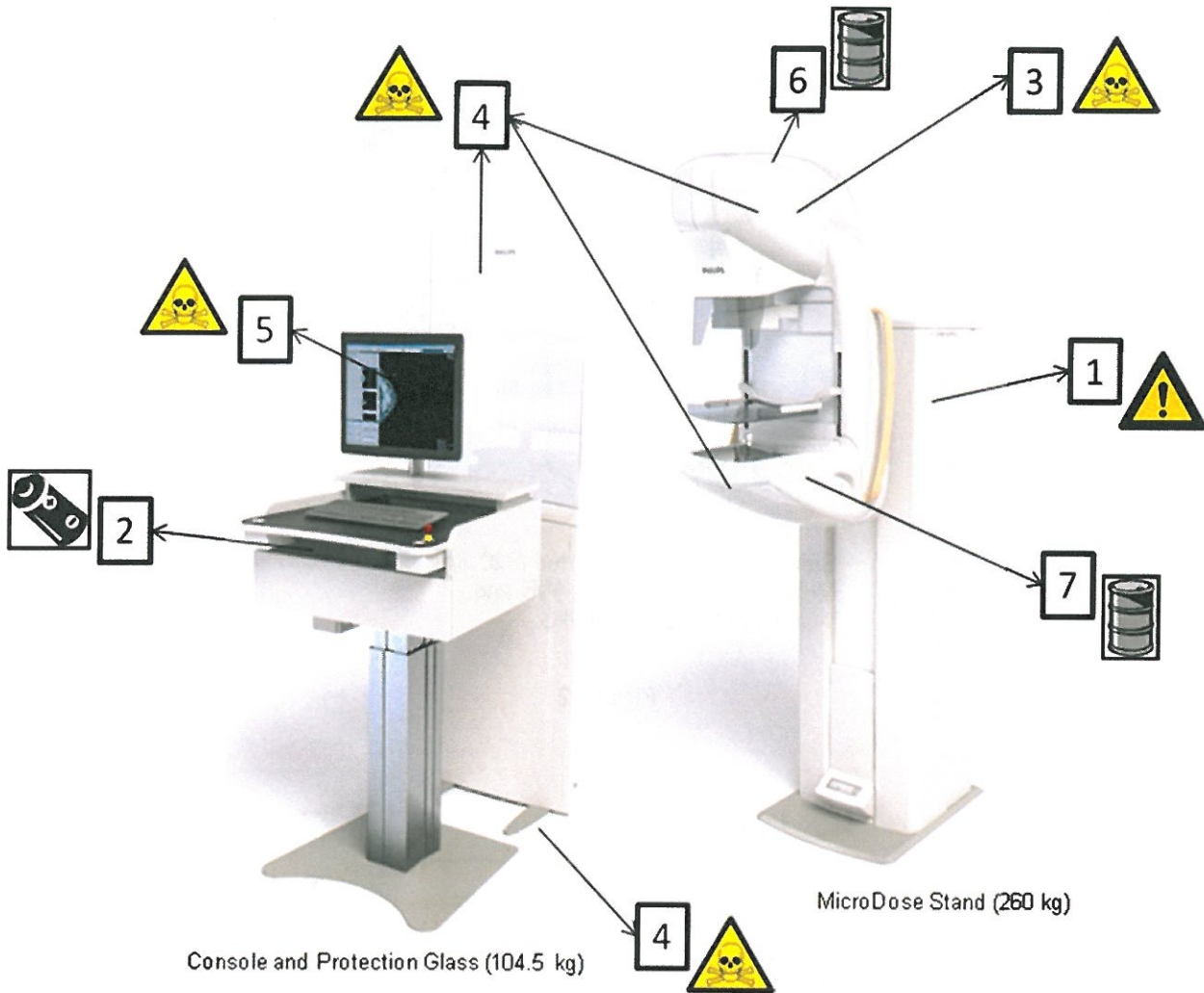
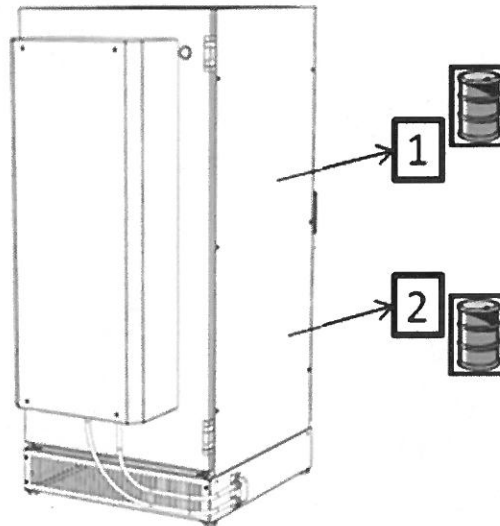

Figure 1

(Passport Header)

PHILIPS HEALTHCARE	Product Recycling Passport	Page 4 of 5
-----------------------	----------------------------	-------------



Side Cabinet Water Cooled (320 kg)  
Models Water 400V L50 WE and  
Water Std voltage L50 WG

Figure 2

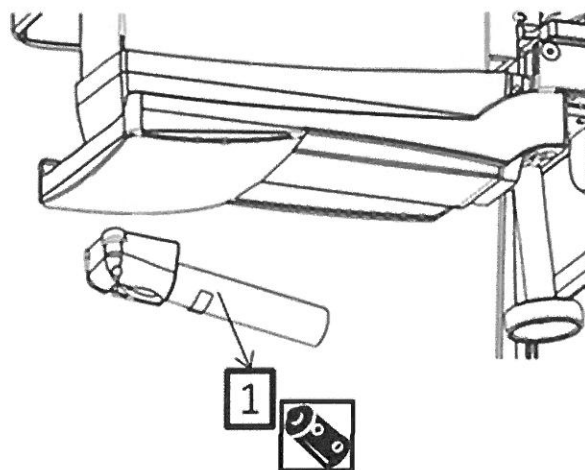

Wire Localization option  
Figure 3