



(Passport Header)



<b>PHILIPS HEALTHCARE</b>	<b>Product Recycling Passport</b>	Page 1 of 5
-------------------------------	-----------------------------------	-------------

<b>Product name:</b>	<b>MicroDose SI</b>	
<b>Identification code(s)</b>	Model Air 400V L50 AE – 4512 2010 9511 Model Air Std voltage L50 AG – 4512 2010 9521	
<b>Total weight (in Kg)</b>	<b>660</b>	
<b>Producer/ Manufacturer</b>	<b>Name company:</b>	<b>Philips Digital Mammography Sweden AB</b>
	<b>Address:</b>	<b>Smidesvägen 5</b>
	<b>Zip code:</b>	<b>SE-171 41 Solna</b>
	<b>Country:</b>	<b>Sweden</b>

<b>Recycle Info</b>	<b>Items:</b>	<b>Location</b>
<b>General Hazards (Desinfection)</b>	For dismantling activities Treatment Facilities must consider the national requirements. For personnel which can come into contact with contaminated material, preventive measures pursuant to national requirements must be taken into account.	
 <b>Fluids / Gases</b>	Oil, remove before dismantling	Figure 1 (6) and figure 2 (1)
	Cooling fluid tank. Remove before dismantling. Waste must be disposed of in accordance with, state and local environmental control regulations.	Figure 1 (7) and figure 2 (2)
 <b>Special attention</b>	Heavy moving parts, dismantle horizontally	Figure 1 (1)

(Passport Header)

<p><b>PHILIPS HEALTHCARE</b></p>	<p align="center"><b>Product Recycling Passport</b></p>	<p align="right">Page 2 of 5</p>
--------------------------------------	---------------------------------------------------------	----------------------------------

	Type:	Location
<p><b>Batteries</b></p>  <p><b>To be Removed</b></p>	<p>CR button battery (Lithium metal) 1x, in computer</p>	<p>Figure 1 (2)</p>
	<p>LR6 AA battery</p>	<p>Figure 3 (1)</p>
	Substances:	Location
<p><b>Hazardous</b></p>  <p><b>To be Removed</b></p>	<p>Beryllium (Be) in X-ray tube</p>	<p>Figure 1 (3)</p>
	<p>Lead(Pb)</p>	<p>Figure 1 (4)</p>
	<p>Mercury (Hg), LCD panel</p>	<p>Figure 1 (5)</p>

**Show locations of materials mentioned on the previous sheet. (Picture information)**

(Passport Header)

PHILIPS HEALTHCARE	<b>Product Recycling Passport</b>	Page 3 of 5
-----------------------	-----------------------------------	-------------

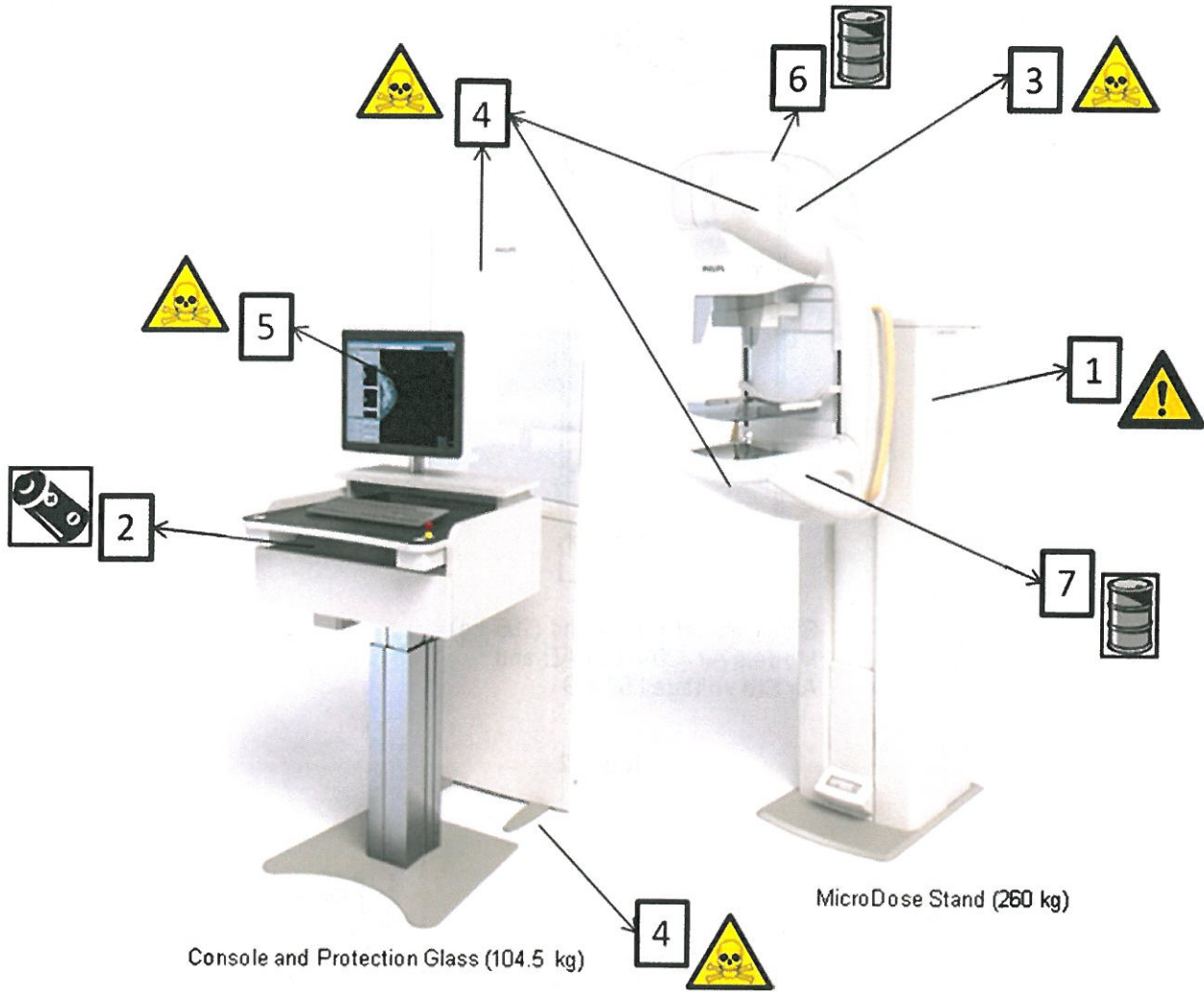
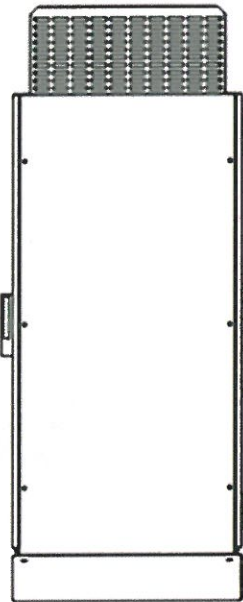

Figure 1

(Passport Header)

<b>PHILIPS HEALTHCARE</b>	<b>Product Recycling Passport</b>	Page 4 of 5
-------------------------------	-----------------------------------	-------------



Side Cabinet Air Cooled (295 kg)  
Models Air 400V L50 AE and  
Air Std voltage L50 AG

Figure 2

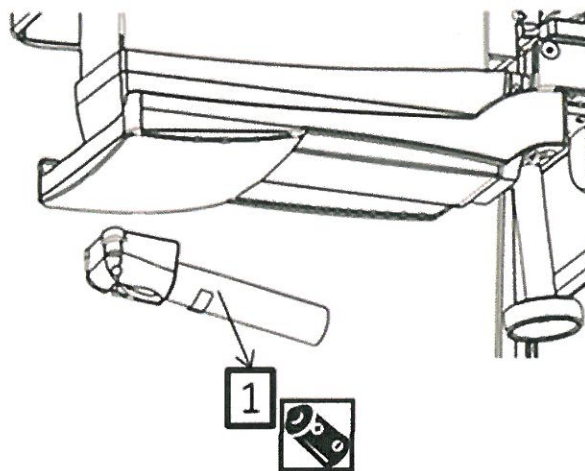

Wire Localization option

Figure 3