





Product name:	PrimaryDiagnost DR	
Identification code(s)	712310	
Total weight (in Kg)	1056 kg	
Producer/ Manufacturer	Name company:	Philips India Limited
	Address:	PLOT NO B-79, MIDC, PHASE II, CHAKAN TALUKA – KHED, VILLAGE – SAVARDARI, DISTRICT: PUNE, MAHARASHTRA
	Zip code:	410501
	Country:	India

Recycle Info	Items:	Location
<b>Special attention</b> 	For dismantling activities Treatment Facilities must consider the national requirements.	--
	Be aware of possible contaminated system parts and materials.	--
	For personnel that can come in contact with contaminated material, preventive measurements pursuant to national requirements must taken into account.	--
	Removal of units/weights can cause the system to tilt	--
	Removal of units/weights can cause unexpected movements	--
	High voltage parts are marked with 	Fig 2[1]
 <b>Fluids / Gases</b>	<b>Items:</b> Di-Electric Oil inside X-ray Tube	<b>Location</b> Fig 1[5]
	<b>Type:</b> Lead Acid (Pb) in UPS Li-ion in generator	<b>Location</b> Fig 3 [1] Fig 2 [2]

	<b>Li-ion in AWS</b>	<b>Fig 4 [1]</b>
<p style="text-align: center;"><b>Hazardous</b></p> 	<b>Substances:</b>	<b>Location</b>
	<b>Lead(Pb) - PCBs in X-Ray Generators</b>	<b>Fig 2[3]</b>
	<b>Lead(Pb) - Xray Tube and Collimator</b>	<b>Fig 1[1,2]</b>
	<b>Anti-Scatter Grid</b>	<b>Fig 1[3]</b>

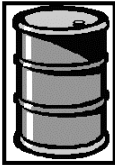
**Show locations of materials mentioned on the previous sheet.**

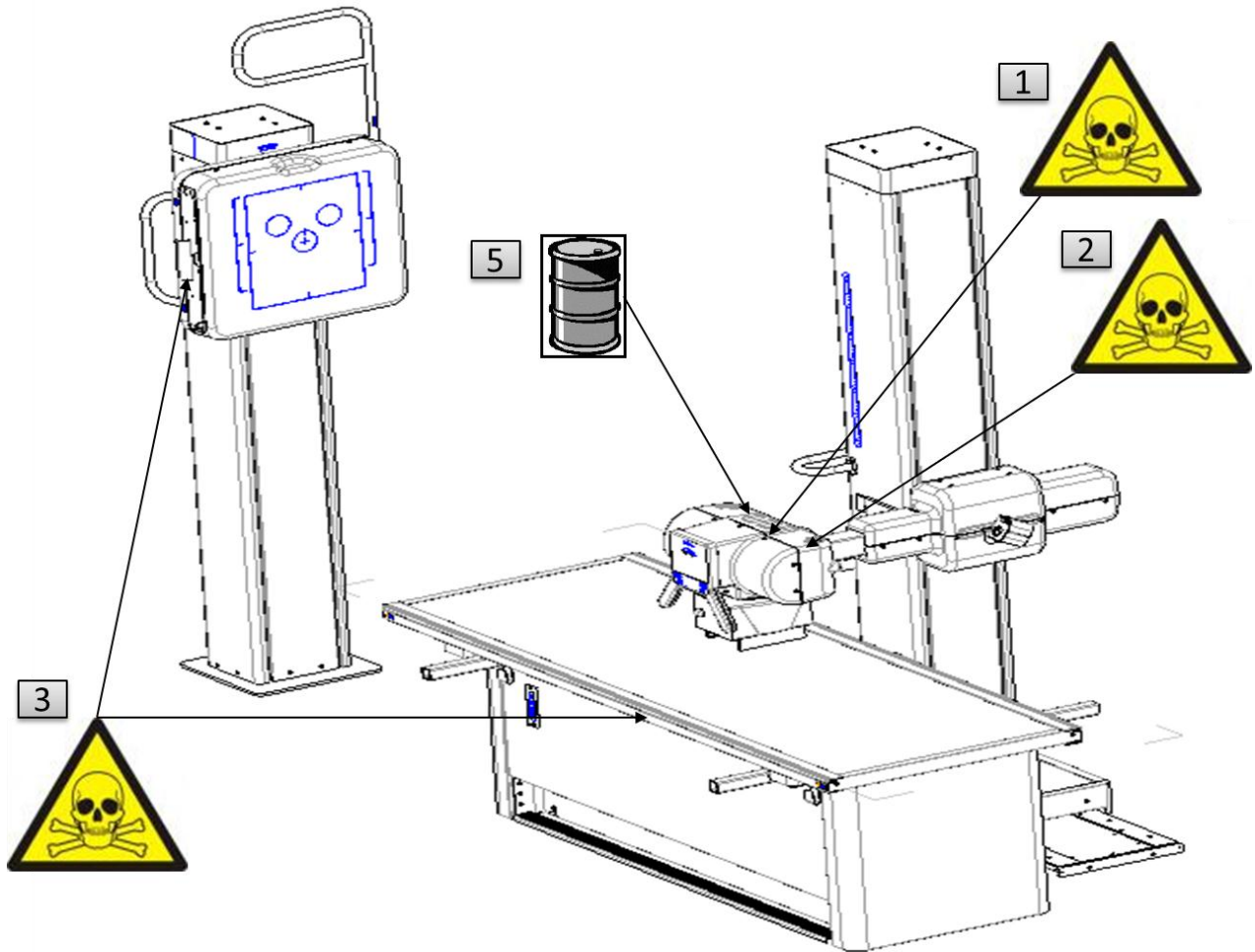

Figure 1

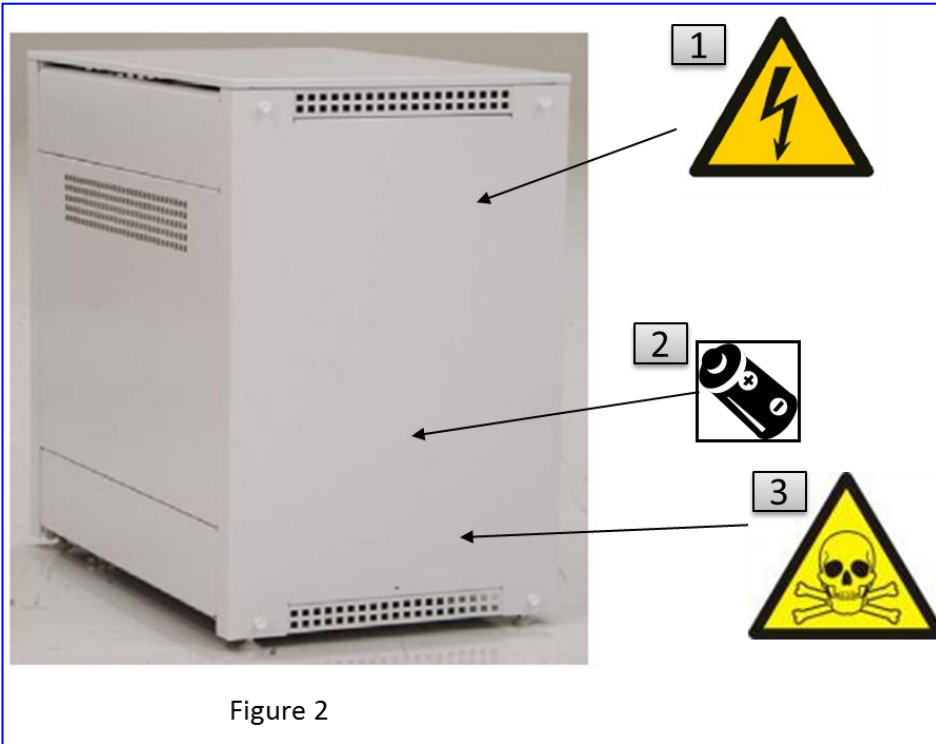

Figure 2

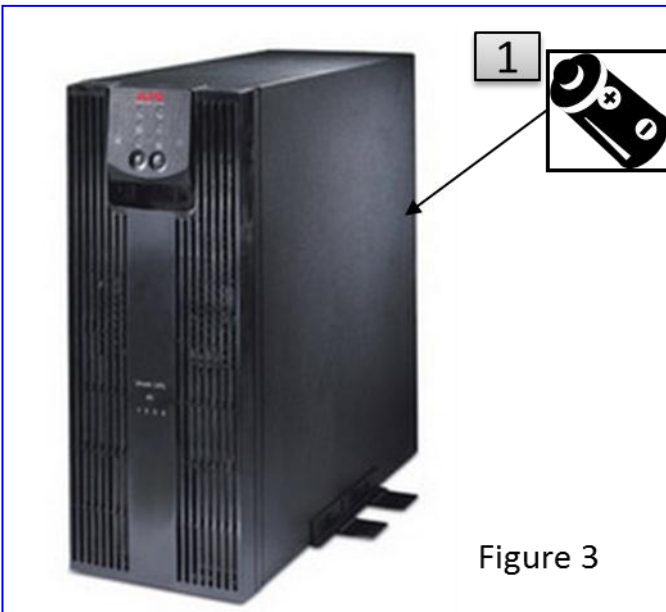
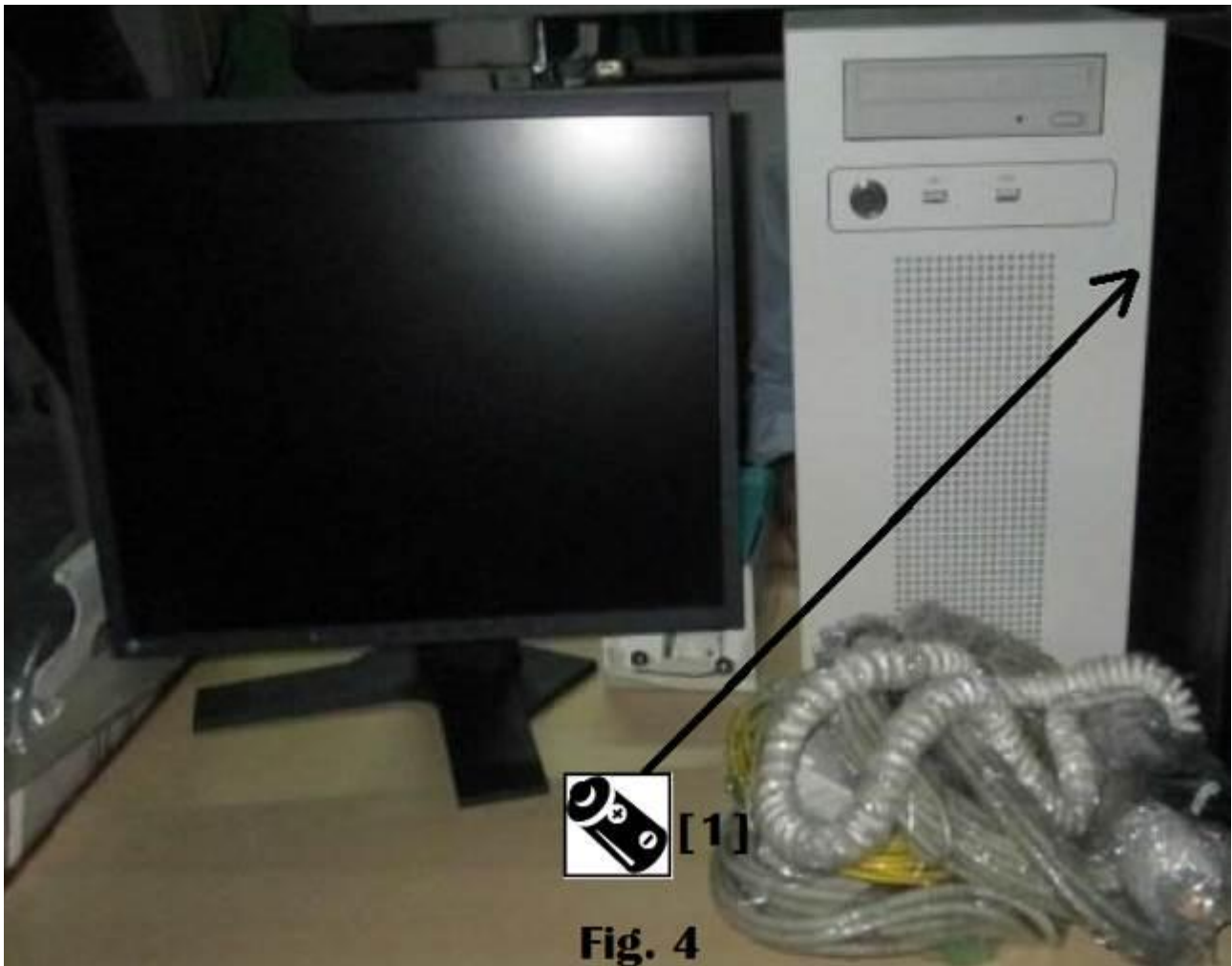

Figure 3



**Recycling Passport Revision History**

Rev	Description	Reason for Change CR/PR ID #	Date
0	Initial Release	--	14th April 2014